

virtu~~fit~~fit

iConsole HTR 2.1 Hometrainer

User manual

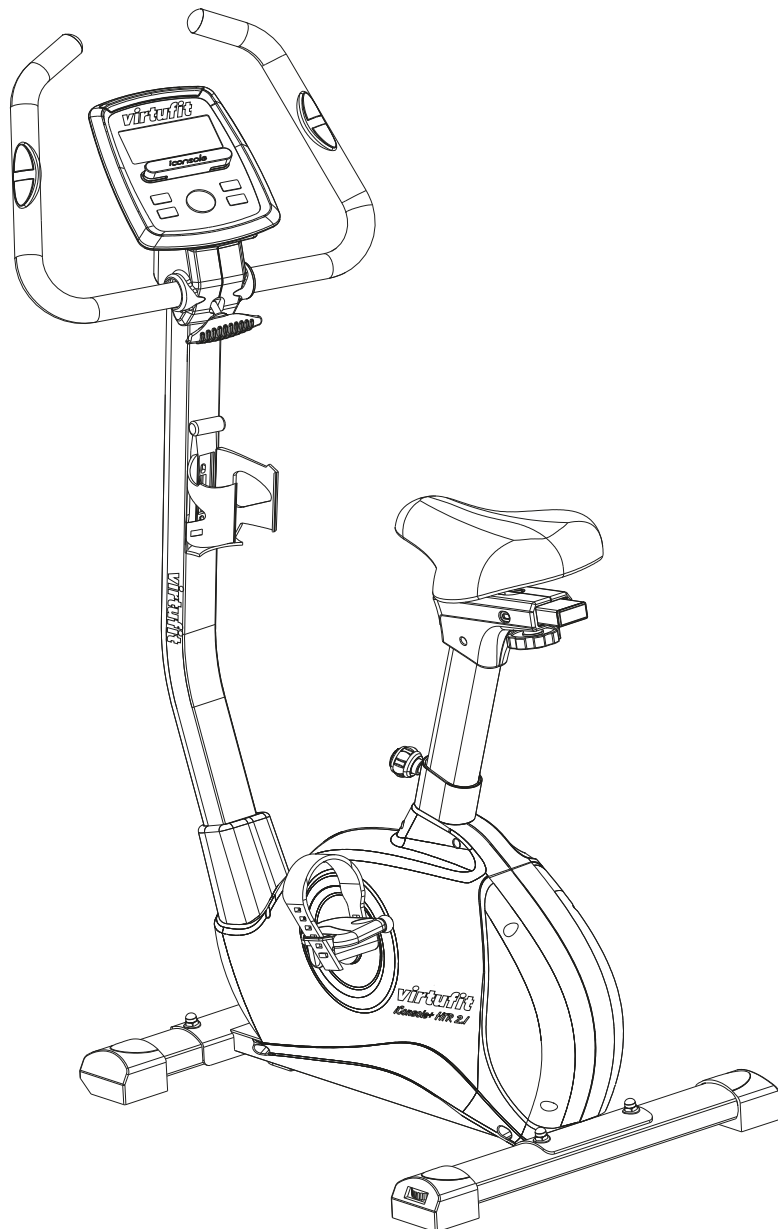

SAFETY INSTRUCTIONS	3 - 4
CHECKLIST	5 - 6
ASSEMBLY INSTRUCTIONS	7 - 14
MAINTENANCE	15
TROUBLE SHOOTING	16
CONTROL PANEL	17 - 23
APP INSTRUCTIONS	24
EXPLODED DRAWING	25
PARTS LIST	26 - 27
TRAINING INSTRUCTIONS	28

WARNING:

Before beginning any exercise program consult your physician. This is especially important for people who are over 35 years old or who have pre-existing health problems. Read all instructions before using any fitness equipment. Do not operate this device without properly fitted guards, as the moving parts can present a risk of serious injury if exposed.

ATTENTION

- It is important to read this entire manual before assembling and using the device. Safe and effective use can only be achieved if the device is assembled, maintained and used properly. It is your responsibility to ensure that all users of the device are informed of all warnings and precautions.
- Before starting any exercise program, you should consult your doctor to determine if you have any medical or physical conditions that could put your health and safety at risk, or prevent you from using the device properly. Your doctor's advice is essential if you are taking medication that affects your heart rate, blood pressure or cholesterol level.
- Be aware of your body's signals. Incorrect or excessive exercise can damage your health. Stop exercising if you experience any of the following symptoms: pain, tightness in your chest, irregular heartbeat, extreme shortness of breath, lightheadedness, dizziness or feelings of nausea. If you do experience any of these conditions you should consult your doctor before continuing with your exercise program.
- Keep children and pets away from the device. The device is designed for adult use only.
- Use the device on a solid, flat level surface with a protective cover for your floor or carpet. To ensure safety, the device should have at least 0.5 metres of free space all around it.
- Before using the device, check that the nuts and bolts are securely tightened.
- The safety of the device can only be maintained if it is regularly examined for damage and/or wear and tear.

- Always use the device as indicated. If you find any defective components while assembling or checking the device, or if you hear any unusual noises coming from the device during use, stop immediately. Do not use the device until the problem has been rectified.
- Wear suitable clothing while using the device. Avoid wearing loose clothing that may get caught in the device or that may restrict or prevent movement.
- The max user weight is 150 KGS. Braking ability is independent of speed.
- The device is not suitable for therapeutic use.
- Care must be taken when lifting or moving the device so as not to injure your back. Always use proper lifting techniques and/or seek assistance if necessary.
- Please keep the space at least 1 to 2 meter at the end of base frame to escape any accidents!
- Place the device on a clean and flat surface. Do not place the device on a thick carpet.
- The device is for indoor use and not for outdoor use to prevent damage. Keep the storage location dry, clean and flat. It is forbidden to use the device for purposes other than training.
- Only use the machine in an environment with an ambient temperature between 10 °C and 35 °C. Only store the device at an ambient temperature between 5 °C and 45 °C.

Warranty claim is excluded if the cause of the defect is the result of:

- Maintenance assembly and repair work not carried out by an official dealer.
- In the event of improper use, neglect and / or poor maintenance.
- Failure to maintain the device in accordance with the manufacturer's instructions (see the enclosed manual).

TOOLKIT

When you open the carton, and you will find the below parts in the carton.

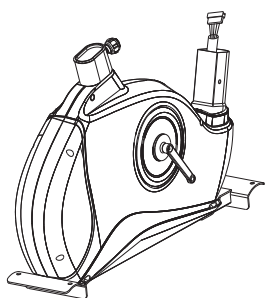

MAIN FRAME

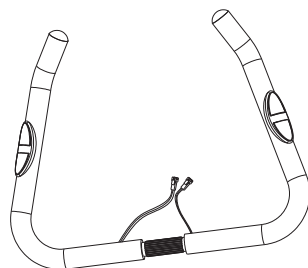

HANDLEBAR

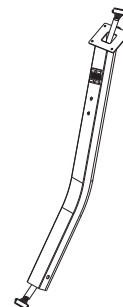

HANDLEBAR POST

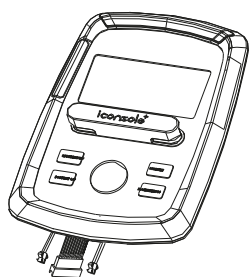

CONSOLE

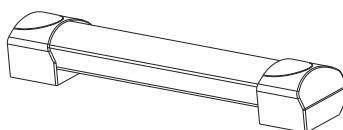

FRONT STABILIZER

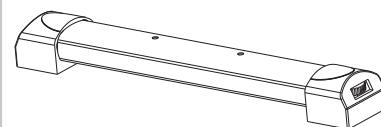

REAR STABILIZER

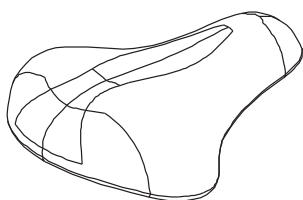

SADDLE

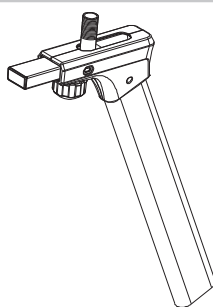

SEAT POST

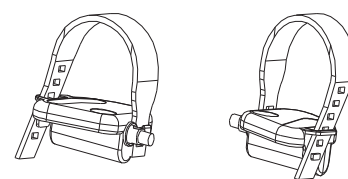

PEDAL (L+R)

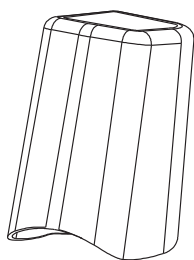

PLASTIC COVER

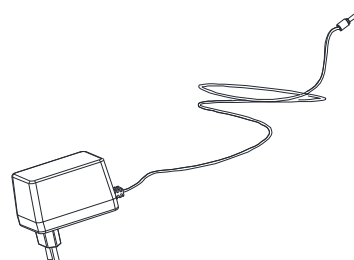

ADAPTER

TOOLKIT

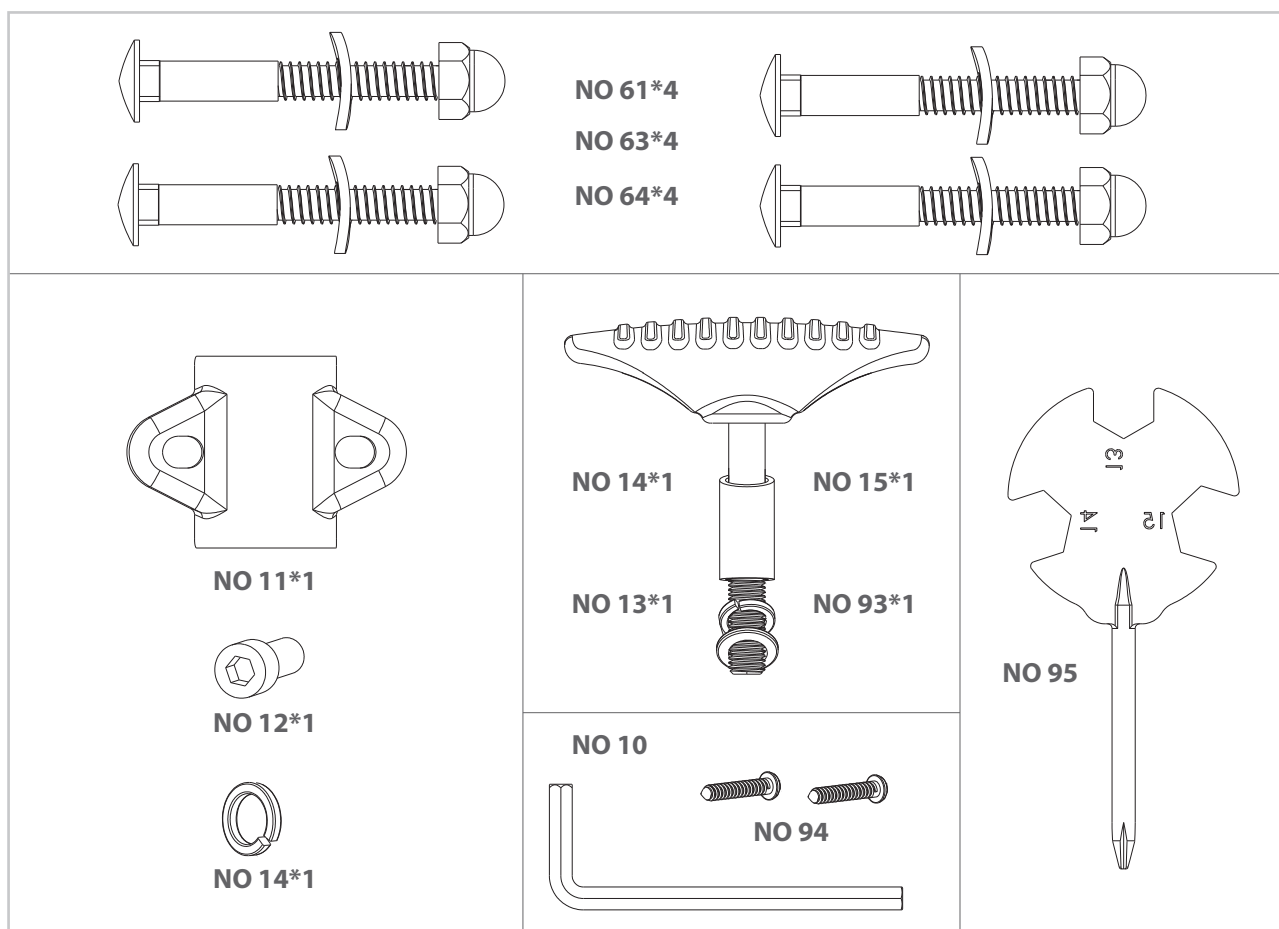

Missing parts: If you think you are missing certain parts in your package, carefully check the styrofoam and the device. Some parts (bolts, screws, etc.) are already attached to/in the device.

Error message: Ensure that all cables are carefully attached. The aluminum legs are very sensitive and must remain straight. Do you receive an error message after mounting your device? Then you have to straighten these aluminum legs again, this may cause the error message to disappear.

Socket screws: The device contains socket screws, make sure that the allen key is firmly in the bolt before you apply force to the key. In this way you prevent the head of the socket head screw from being rotated.

STEP 1

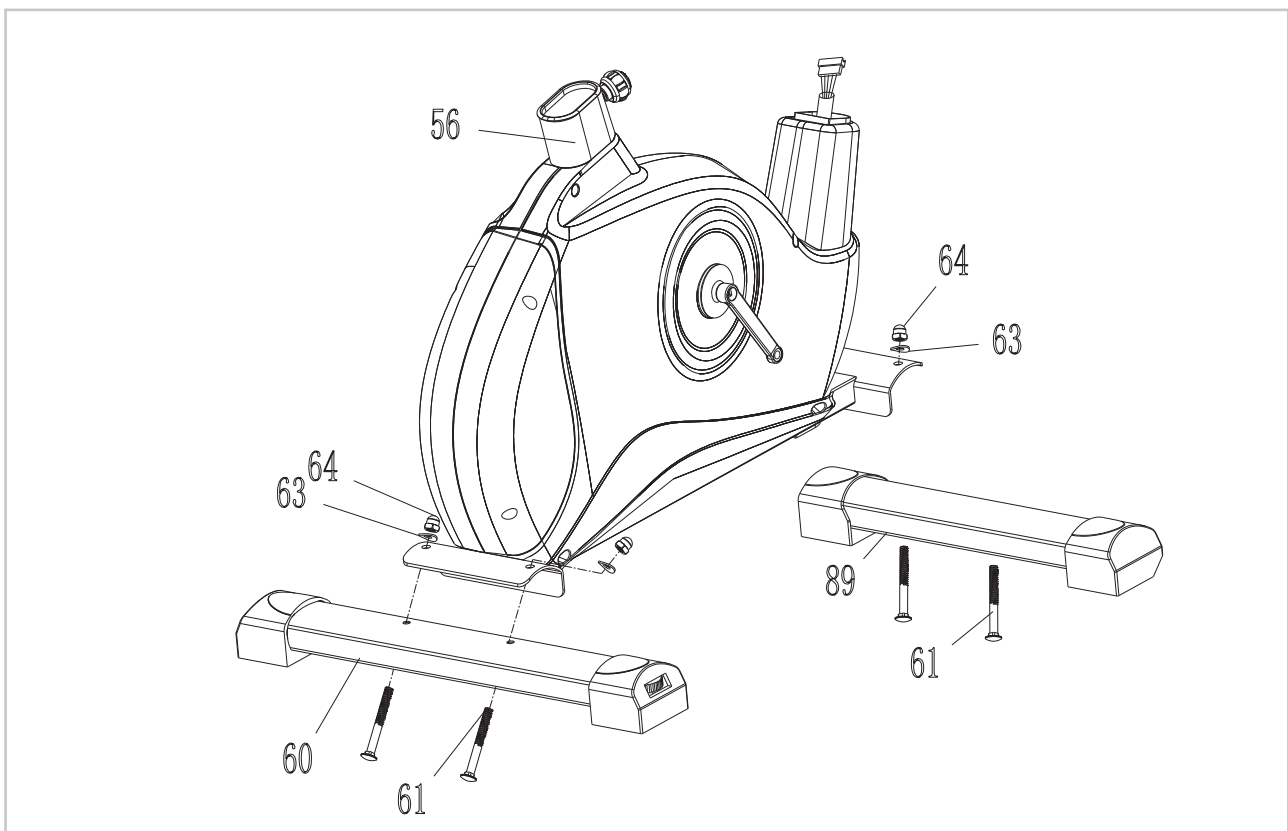

- Attach the front stabilizer (89) to the frame (56) with 2 × M8 screws (61), curved washer (63) and cap nut (64). Tighten the nuts properly..
- Attach the rear stabilizer (60) to the frame (56) with 2 × M8 screws (61), curved washer (63) and cap nut (64). Tighten the nuts properly.

NOTE: You can adjust the Rear End Cap to keep the hometrainer stable.

STEP 2

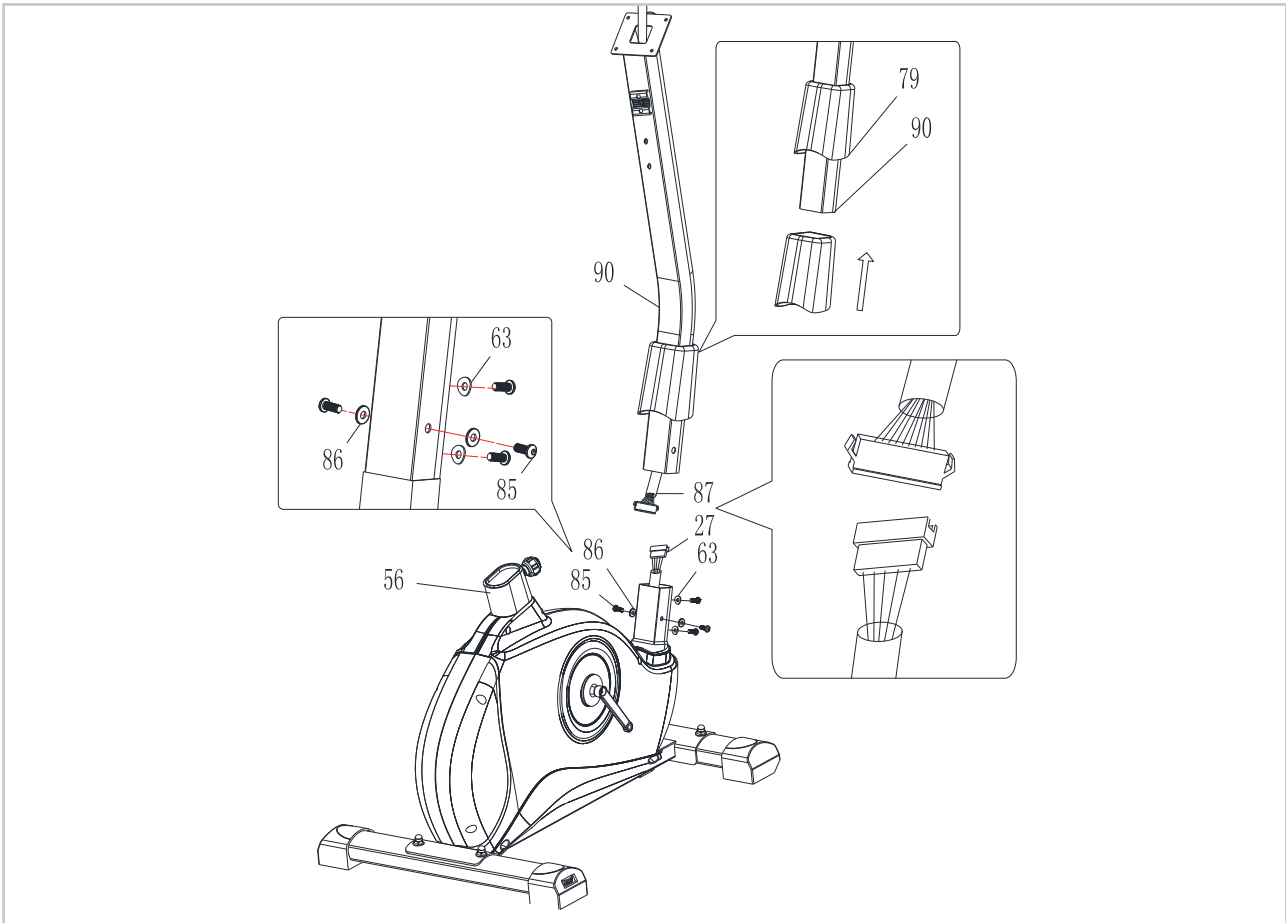

- Carefully lift the Handlebar Post (90) until it is vertical. And slide onto the plastic cover (79). Connect the upper Tension Cable (87) and Lower Tension Cable (27).
- Attach the handlebar (90) to the frame (56) with 4 × M8 × 20mm anti-loose bolts (85), 2 × M8 elbow washers (86) and 2 × M8 flat washers (63).

STEP 3

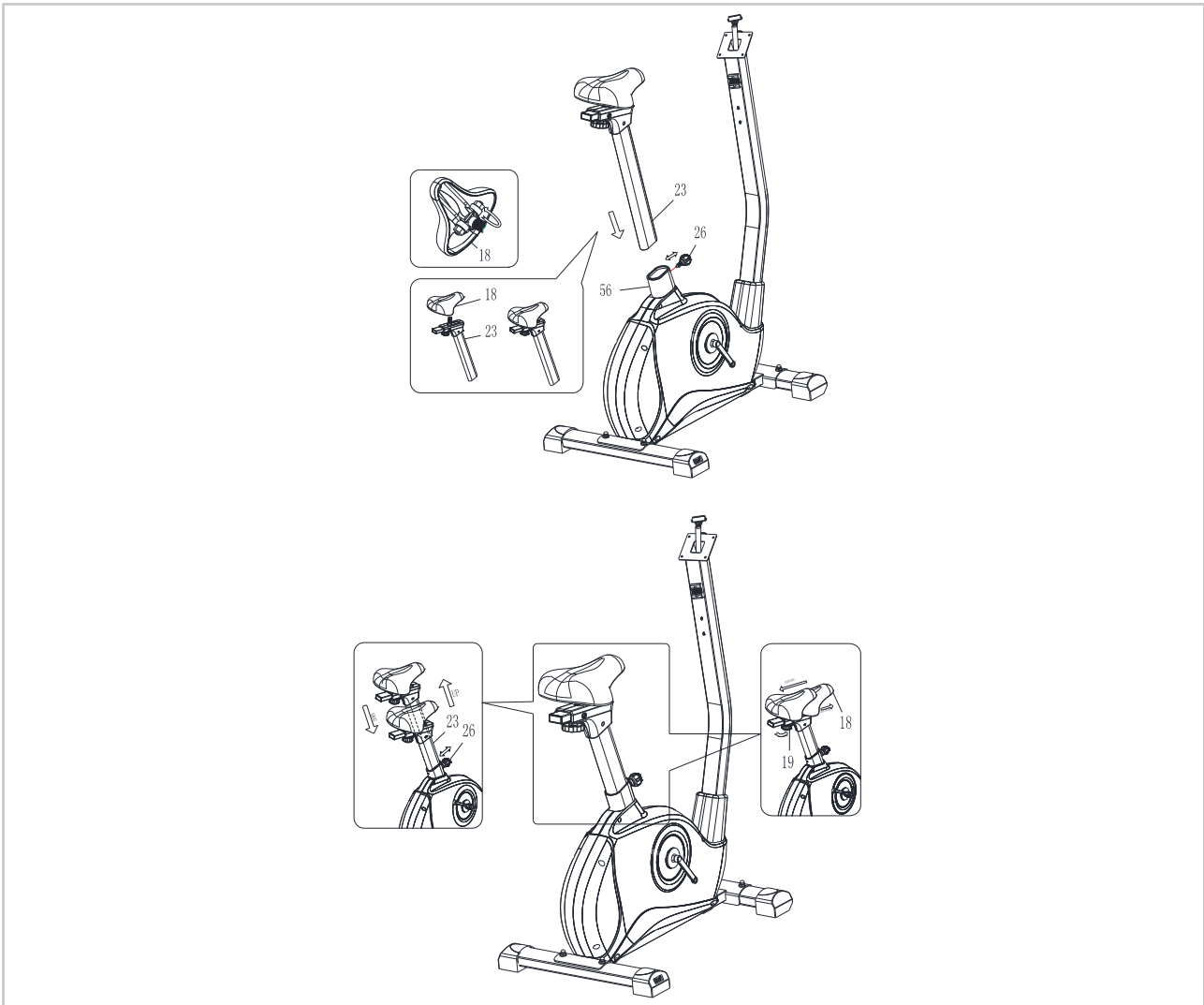

- Install the saddle (18) on the adjustable saddle bar (23). Place the seat post (23) on the frame (56), adjust as desired and tighten with the Quick Release bolt (26) and tighten securely On.
- The saddle can be adjusted fore and aft by turning the knob (19).
- The saddle bar can be easily adjusted by pulling out the Quick Release knob (26).
- In addition, make sure that the saddle bar is not extended beyond its maximum position. This one maximum position is marked.

NOTE: When the saddle bar is at the desired height, tighten the knob securely.

STEP 4

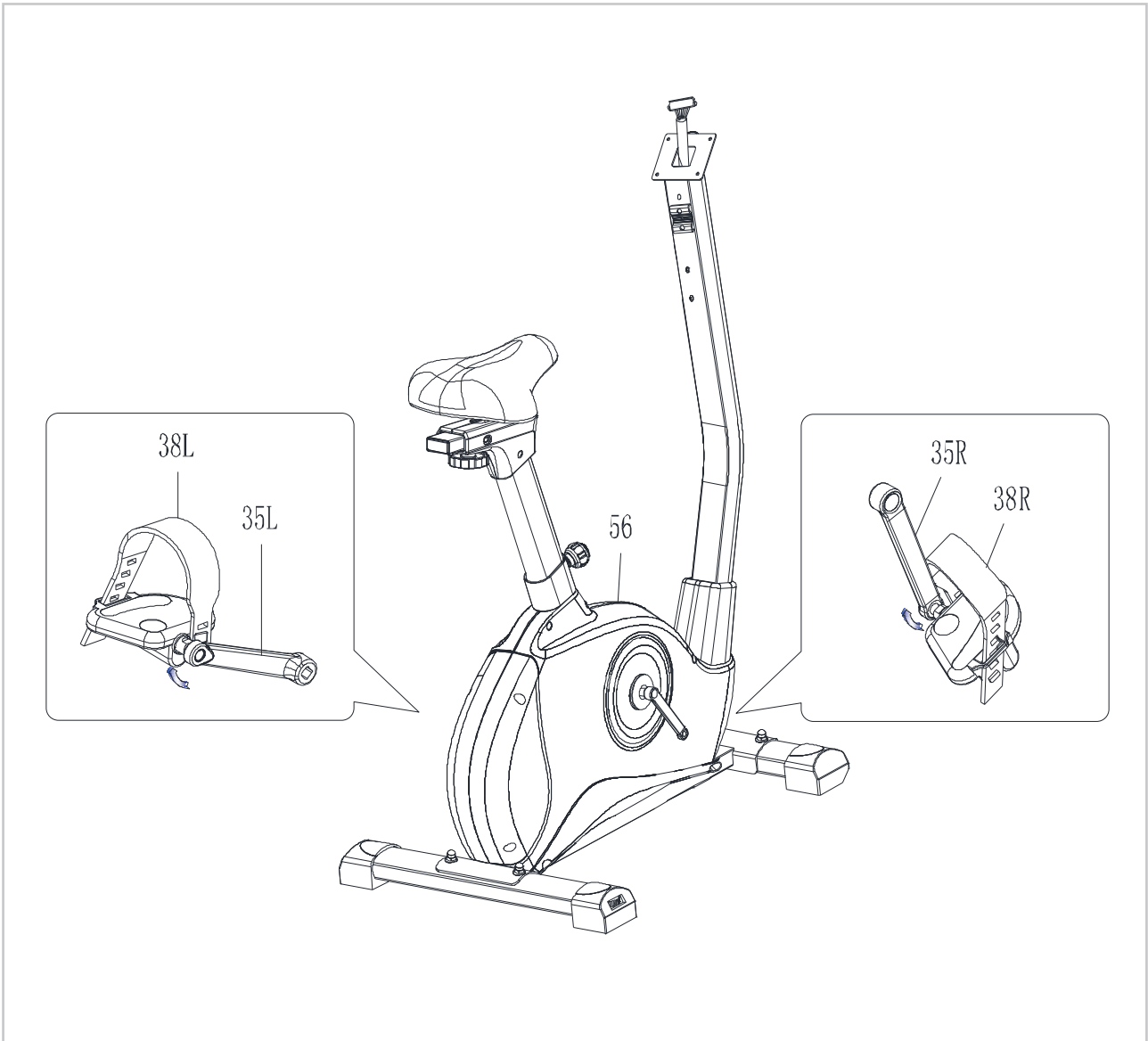

- Attach the pedals (38L + R) to the crank (35L + R).

NOTE: Take a good look at the course of the screw thread. Screw it on well and not askew. In addition, also tighten the pedal.

STEP 5

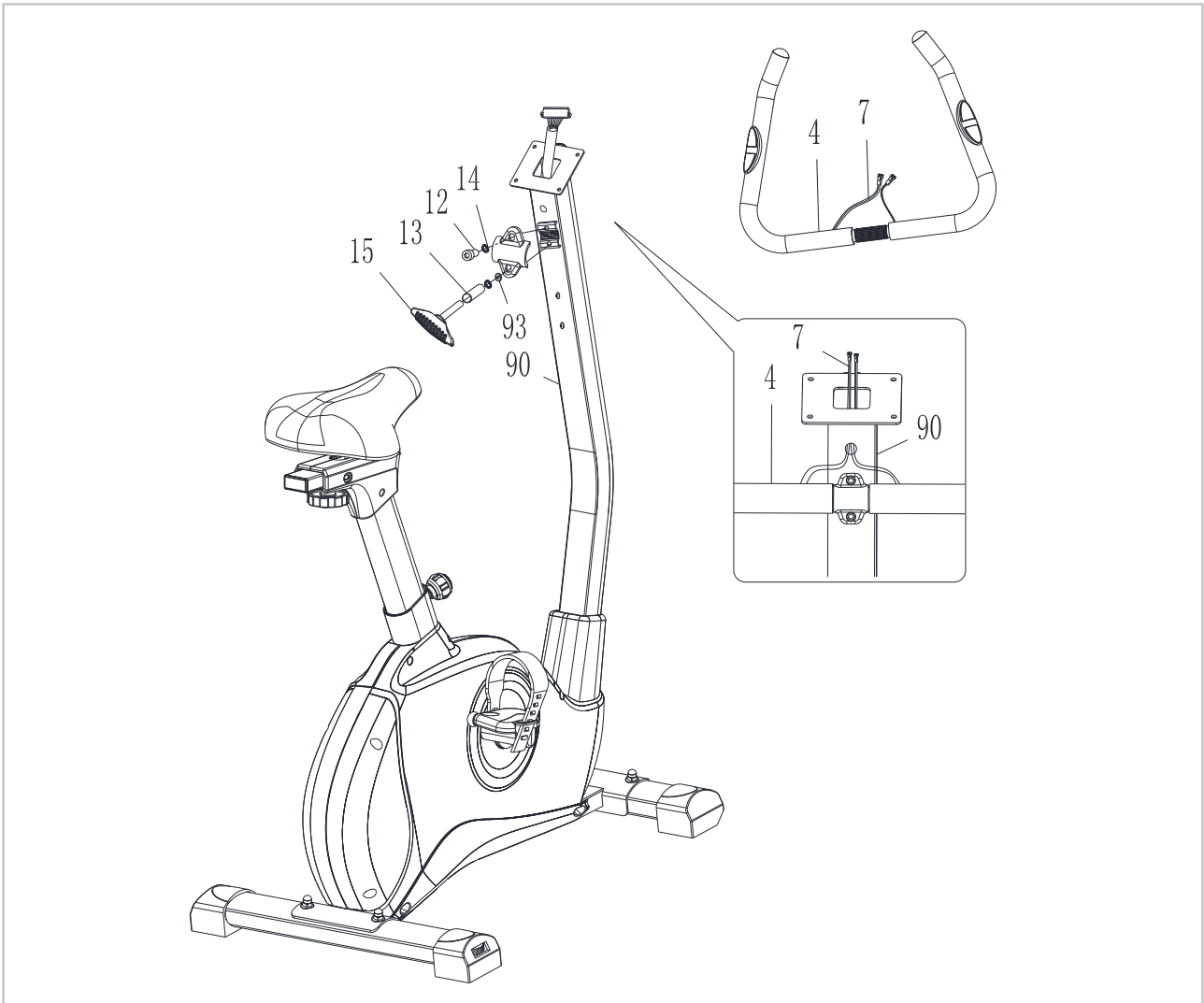

- Mount the handlebar (4) on the handlebar (90) with the spring washer (93), tubular spacer (13), plastic cap (12) and knob (15).
- Install the spring washer (14) and round hexagon screw (12).
- Pass the sensor cable over the console and fix everything properly and completely.

STEP 6

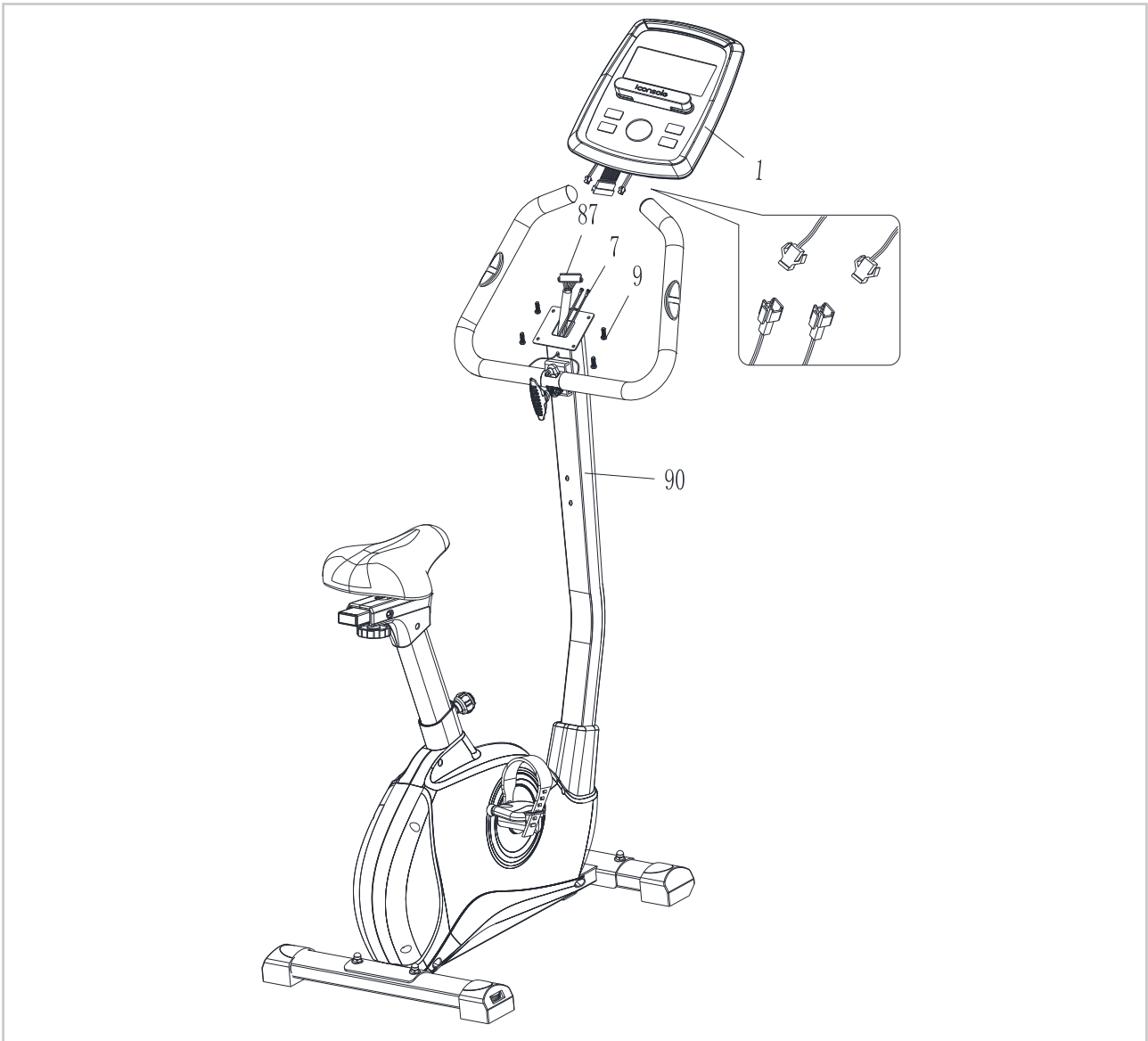

- Remove the 4 pre-rotated screws (9) from the back of the computer.
- Connect the computer cable (87) and the computer (1). Place the computer (1) on the handlebar and fix it with the previously removed screws (9)..
- Plug the hand sensor cable (7) into the connector on the back of the computer (1).

STEP 7

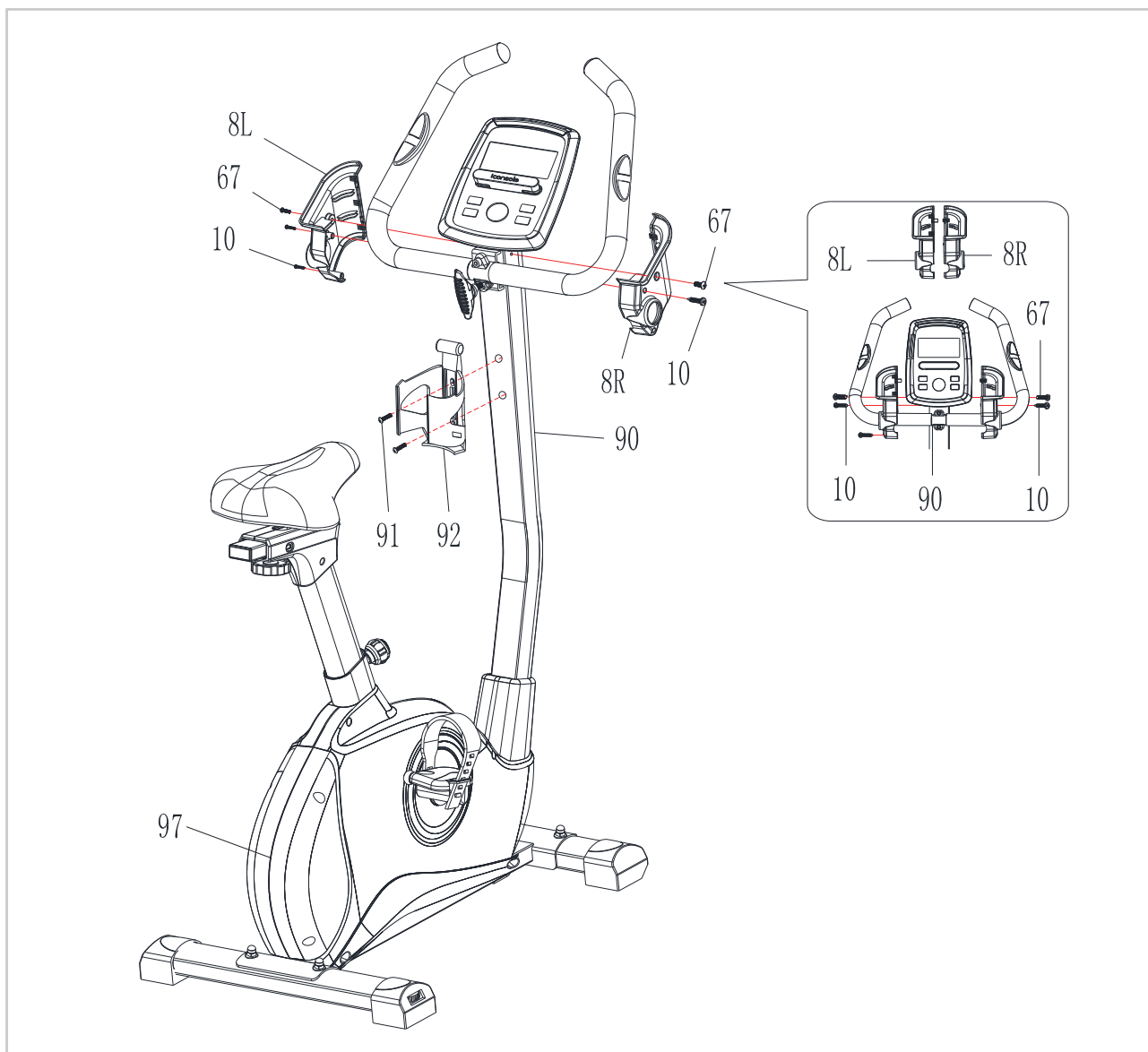

- Attach the console caps (8L + R) to the handlebar (90) with screws (67) and self-tapping screws (10).
- Attach the bottle cage (92) to the handlebar (90) using screws (91).

ADAPTER



- The adapter connection is located on the back of the device (see image).
- Attach the adapter to the adapter connector and connect to AC power.
- You can now use the exercise bike.

Safe and effective use can only be achieved if the device will be assembled and maintained well. It is your responsibility to ensure that the equipment is regularly maintained. Parts that are already used and / or damaged must be replaced before continuing using. The rower machine may only be used indoors and stored away, prolonged exposure to weathering and changes in temperature / humidity can have a serious impact on the electrical components and moving parts of the device.

DAILY MAINTENANCE

- Clean and remove sweat after each use Do not use aggressive cleaning agents and ensure that the device remains free of moisture.
- Check that the rail and the wheels under the seat are free from dust and dirt.

SEMI-ANNUAL MAINTENANCE

- Inspect all bolts and nuts in connection with moving parts of the device, tighten as required.
- Check the mobility of moving parts and components of the use equipment, silicone spray if necessary.

Display shows no values

If the display does not show any values, you can try to check the sensor cables and the cables in the back of the display. If this still does not work, you can move the sensor slightly.

The device beeps

If necessary, lubricate parts with silicone spray. Check that all nuts and bolts are tightened. It may be that a screw is too loose or too tight, this creates friction and makes the device appear to beep. If this is the case, try to find out exactly where the beep comes from and then tighten or loosen this screw. It must always be possible to loosen the screws with your hands. If this is not possible, the screw is too tight.

No resistance

First check whether you can hear the motor running. You will hear the motor running briefly when you increase or decrease the resistance. If you hear the engine running, all electronics are in order, but the V-belt is probably over. You can then open the housing and put the V-belt back on it. If you do not hear the motor running, it is possible that the motor or the display is defective. First check whether the cable running upwards in the pipe is still properly connected.

Ticking sound

It is possible that the flywheel (in the housing) comes against a cable with each pedaling movement. This may be disturbing but will not permanently damage your crosstrainer. To fix this, open the housing and move the cable or fix it with for example a tie wrap.

Heart rate display is not functioning

There can be various reasons for this:

- The sensor cables that run from the heart rate sensor to the display are not properly installed or have become detached during use.
- The sensors may become damp, dirty or greasy. So you have to clean them regularly.

The console is not working

If there is no signal when pedaling, check if the cable is properly attached.

CONSOLE

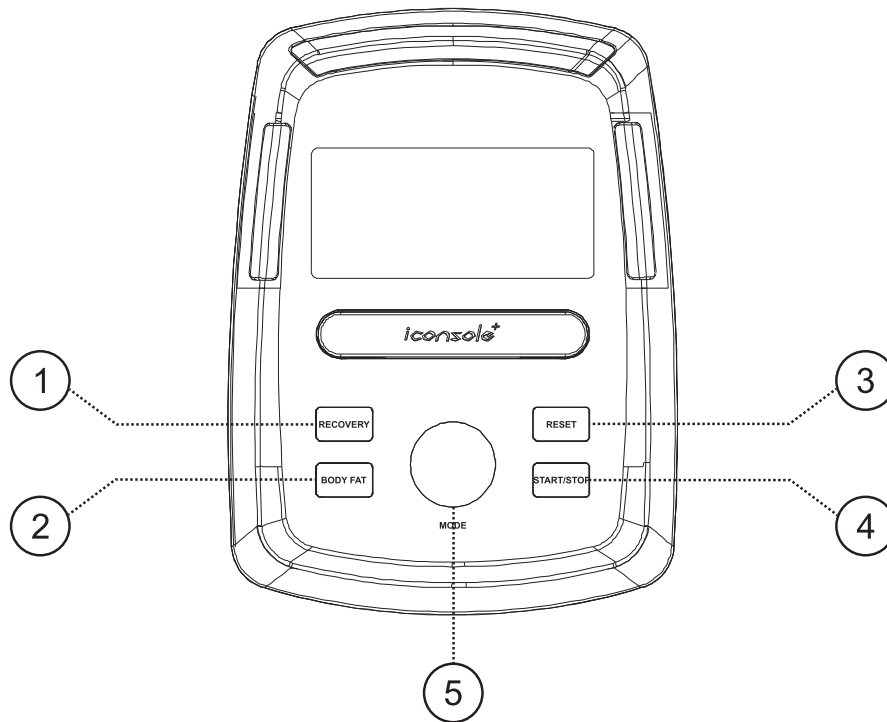

BUTTON	FUNCTION
(1) RECOVERY	Heart rate recovery test.
(2) BODY FAT	Fat percentage and BMI.
(3) RESET	<ul style="list-style-type: none"> • Computer restarts after pressing and holding for 2 seconds. • Return to main menu, restore the value or stop mode.
(4) START / STOP	Start or stop the training.
(5) ENCODER	<ul style="list-style-type: none"> • Increase or decrease the value. • Confirm the value selection

FUNCTIONS

FUNCTION	EXPLANATION
TIME	The total time from the beginning to the end of the workout is displayed.
SPEED	The speed is displayed during the exercise when you start exercising.
DISTANCE	The distance of the workout is displayed when you start exercising.
CALORIES	The calories burned are displayed during the workout.
PULSE	Your heart rate during exercise is displayed. Heart rate alarm if the heart rate is higher than the target.
RPM	Revolutions per minute.
WATTS	Displays the wattage.
MANUAL	Functions change automatically every 6 seconds.
PROGRAM	Choice of 12 programs.
USER	Manual selection. User determines his own resistance program.
H.R.C.	Heart Rate Control. Heart rate based program.
RECOVERY	Heart rate recovery status.
BODY FAT	Body fat measurement.

OPERATION

START

1. Plug in the power cord (or press and hold RESET button for 2 seconds), the display will light up and make a sound

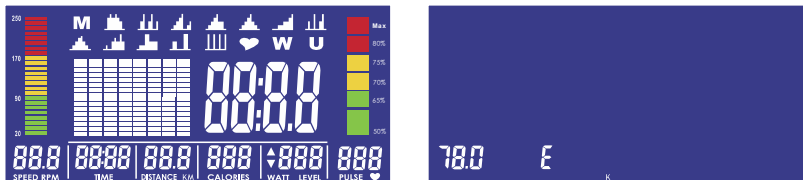

2. Turn the knob to select a user profile 1-4. By clicking on the round button you select a profile.
3. After this you can enter your gender by turning the knob. Press the round button to confirm. This also applies to your age, height and weight. After this you go to the programs.
4. You can also start quickly by pressing the START button directly. You will immediately enter the manual program. Increase the resistance by turning the knob.



5. Door te draaien aan de ronde knop selecteert u welk programma u wilt, dit kunt u zien aan het knipperende logo bovenin beeld.
6. By turning the round knob you select which program you want, this can be seen from the flashing logo at the top of the screen.
7. The M stands for Manual. You can adjust the resistance yourself in the program. Pressure start to select a program. By turning the rotary knob you can select different select programs. Press start to start the program. Do you want to adjust the program on time or at a desired number of calories? Then first press the round button. Which that flashes you can increase / decrease by turning the knob. Press the button to confirm. Press start to start the program.
8. With the manual program you can set different values, with the pre-programmed programs only time.

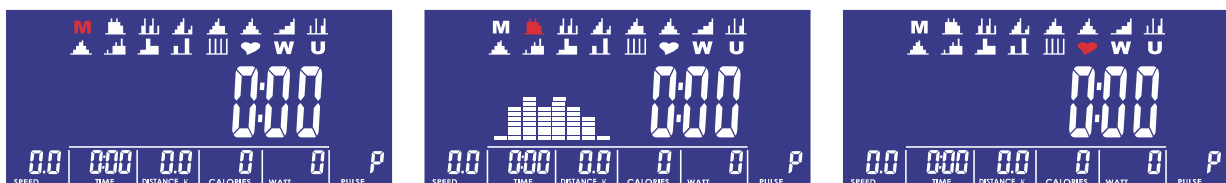

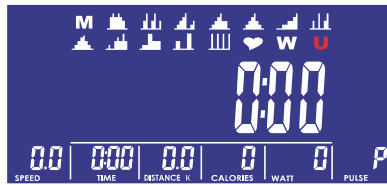
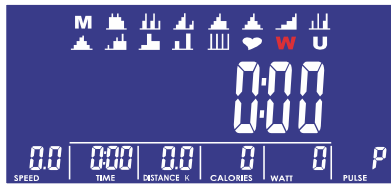

MANUAL MODE

1. When in manual mode you can increase and decrease the resistance with the rotary knob.
2. By pressing "START" distance, time, calories and pulse can be increased and decreased. You can select 10 minutes, for example, the time will count down. So you can get a workout of 10 minutes.

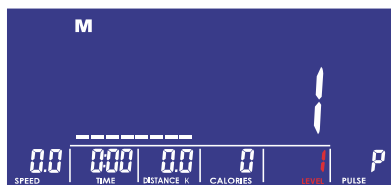

4-1

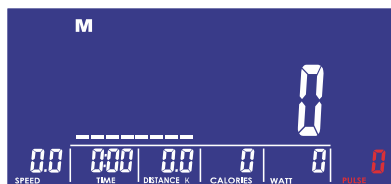

4-2

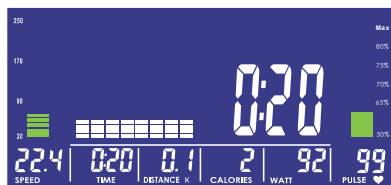

4-3

PROGRAM MODE

1. When Press and hold the RESET button until the unit beeps.
2. Select a USER 1-4 by pressing the round button. Hold down until the screen appears as in the drawing on the next page. The M of MANUAL will now flash. By turning the round knob you can now select a program.
3. Press the round button to confirm the program. With another push of a button you can difficulty setting by turning afterwards. The time flashes after the button is pressed. You can now set the time by turning the knob. Select the desired time and press "START" to start the program.

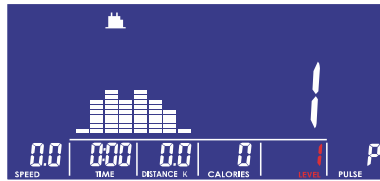
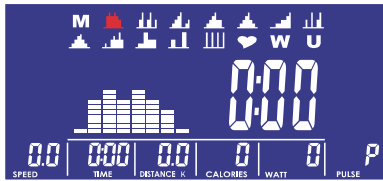

H.R.C. HEART RATE MODE

1. The user can select 55%, 75%, 90% and target values by turning the button. TARGET can be set not to exceed a certain value. Should this set to 80 beats per minute and you come up above, the device will beep. Note: the heart rate measurement should not be used for medical purposes and is only one approach.
2. Start the appliance. Press the round knob to set USER 1-4 and then rotate from the home screen to the HEART symbol. Press the round button. Turn the knob to select. Press on the button to choose. After that time can be set by turning and pressing and the button. Pressure then press START to start.

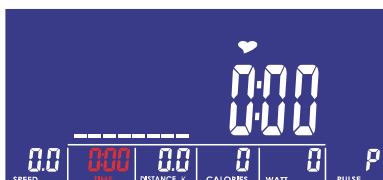
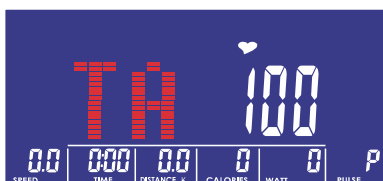
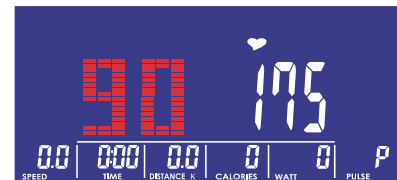
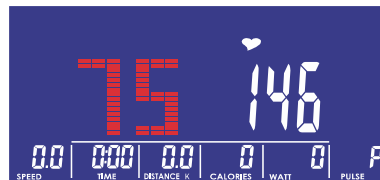
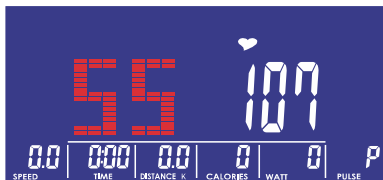
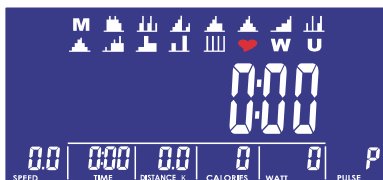

WATT MODE

1. You can adjust the WATT values by turning and then pressing the knob. Through again, you can also set the time.
2. Press START to start exercising. The WATT can be adjusted during training. You can enter a maximum value. If you go over this, the device will beep.

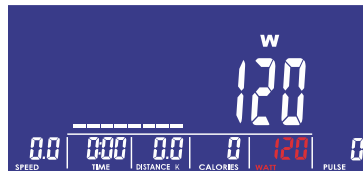
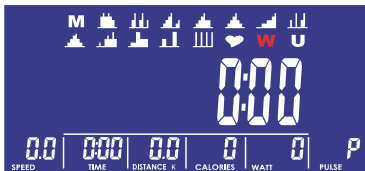

USER PROGRAM MODE

In this mode you can compile your own program.

1. Druk en draai op de ronde knop om de U te selecteren. Press and turn the round knob to select the 'U'.
2. Press and turn the knob to change the resistance per bar.
3. Press START to begin. Press START again to set the time if necessary turn the knob. Press START again to resume. The resistance will change automatically as you have set it.

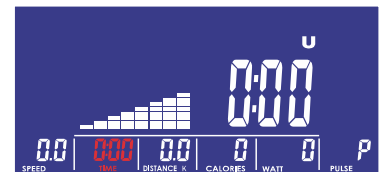
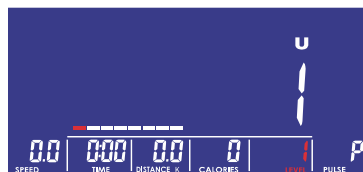
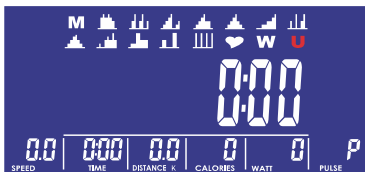

BODY FAT MODE

1. Press the Body Fat button. Then you can choose from U1-U4 to select your user program which you can change when starting up or resetting the device.
2. After selecting, you can place your hands on the heart rate sensors on the handlebars.
3. After a few seconds, an approximation of your BMI (B) and your body fat percentage (F) will appear.

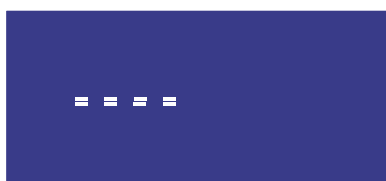
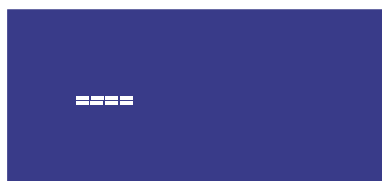

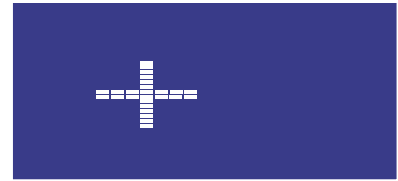
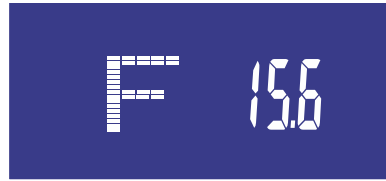
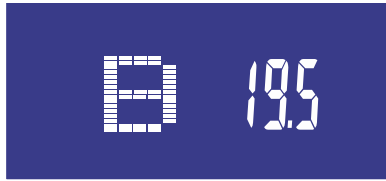

RECOVERY MODE

This mode measures how quickly you recover from a workout.

1. Make sure the device measures your heart rate during exercise. When you take a heart rate measurement press "RECOVERY" during your workout.
2. Time and heart rate are displayed. The time counts down from 60 seconds and the current heart rate becomes shown. You do not have to cycle.
3. The faster your heart rate drops, the better your fitness.

NOTE: *This is an estimate. The results should not be used for medical purposes.*

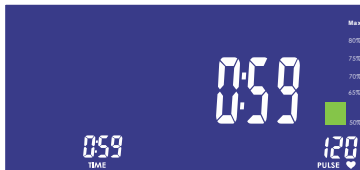

1.0	OUTSTANDING
1.0 < F < 2.0	EXCELLENT
2.0 < F < 2.9	GOOD
3.0 < F < 3.9	FAIR
4.0 < F < 5.9	BELOW AVERAGE
6.0	POOR

INSTRUCTION

1. QR code scanner app is required to scan the QR code with an Android or IOS phone or tablet. This app can be downloaded in the App Store or Google Play Store.
2. Scan one of the QR codes below to go directly to the place in the App Store or Google Play Store where the app is located and can be downloaded.
3. Scan the QR code on the right to go to the user manual of the app. The manual describes step by step how the app should be connected to the device, how the app works and what the options are.

ICONSOLE+

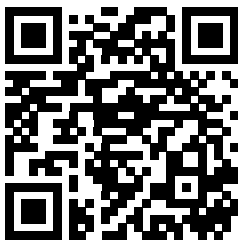

APP STORE
ICONSOLE+



GOOGLE PLAY
ICONSOLE+

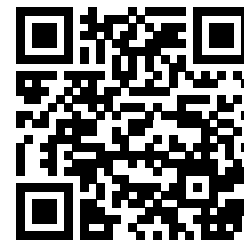

USER MANUAL
ICONSOLE+

KINOMAP

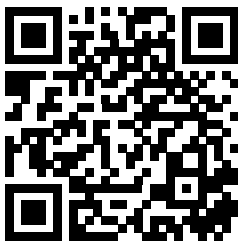

APP STORE
KINOMAP

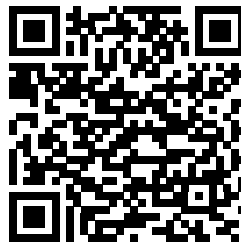

GOOGLE PLAY
KINOMAP

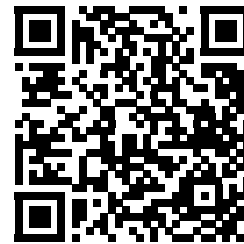

USER MANUAL
KINOMAP

VirtuFit does not provide service for third-party fitness apps such as Kinomap, iConsole, FitShow etc.. If you encounter any troubles with a third-party fitness app, please contact the app developer.

EXPLODED DRAWING

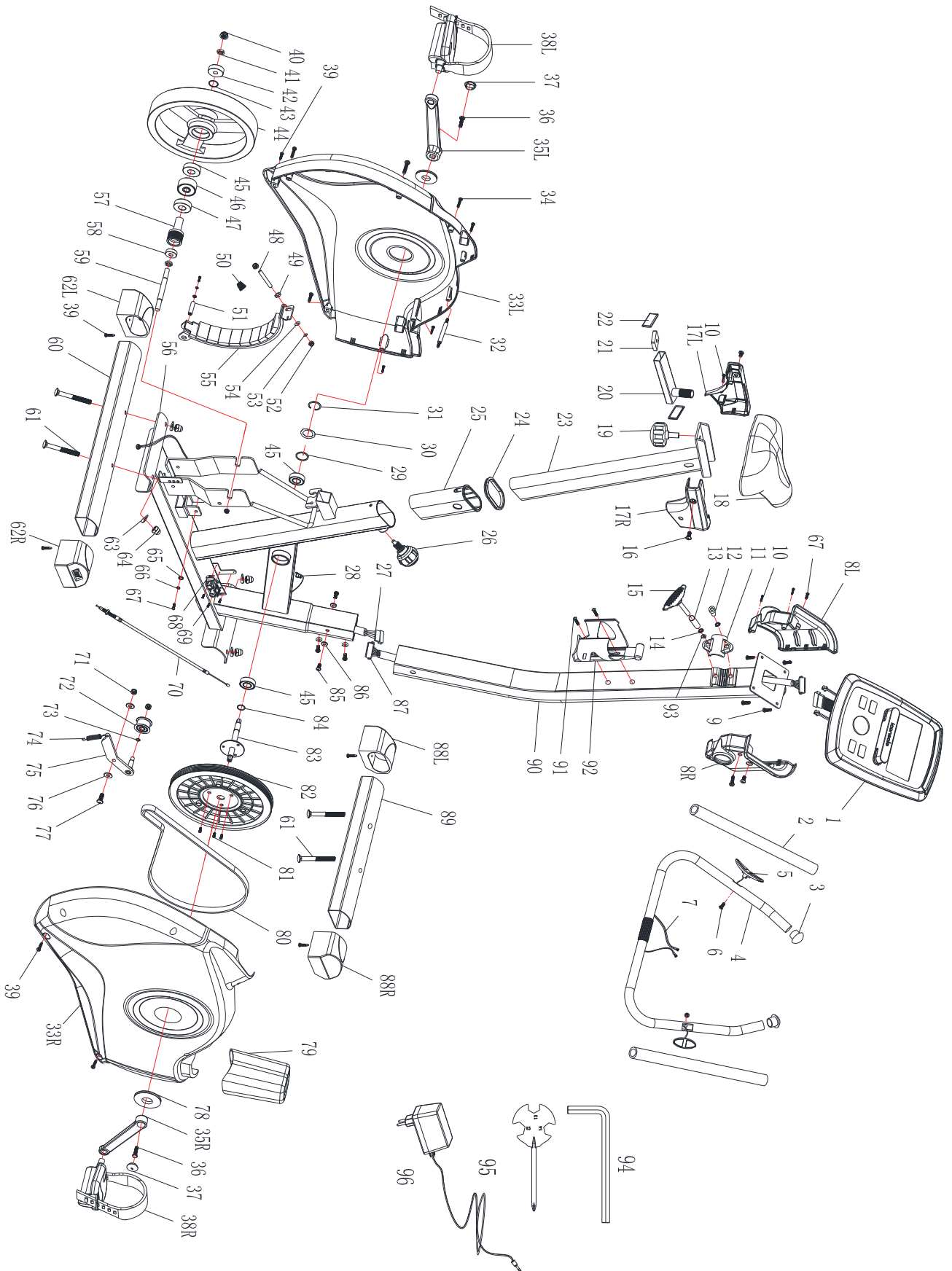

#	DESCRIPTION	QTY
1	Computer	1
2	Sponge Foam	2
3	End cup	2
4	Handlebar	1
5	Hand pulse pads	2
6	Self-tapping screw	2
7	Hand pulse cable	2
8L	5204 computerbracket L	1
8R	5204 computerbracket R	1
9	Screw	4
10	Self-tapping screw	4
11	End cap	1
12	Screw	1
13	Tube spacer	1
14	Washer	2
15	T shpar knob	1
16	Screw	2
17L	seat post plastic cover L	1
17R	seat post plastic cover R	1
18	Saddle	1
19	Round head hex screw	1
20	Slide tube	1
21	Slide tube hold-down nut	1
22	Square tube end cap	2
23	Seat post	1
24	Gasket ring	1
25	Ellipse bushing	1
26	Knob	1
27	Lower computer cable	1
28	Sensor	1
29	Flat washer	1

#	DESCRIPTION	QTY
30	Curved washer	1
31	C shaped washer	1
32	Joint lever	1
33L	5204 Chain Cover(L)	1
33R	5204 Chain Cover(R)	1
34	Self-tapping screw	5
35L	Crank L	1
35R	Crank R	1
36	Screw	2
37	Crank end cup	2
38L	Pedal L	1
38R	Pedal R	1
39	Screw	8
40	Nut	2
41	Hex Nut	2
42	Bearing 6300RS	2
43	Flat Washer	1
44	Magnet flywheel	1
45	Bearing 6003RS	3
46	Bearing	1
47	Bearing 6003RS	1
48	Bushing	1
49	Hex Nut	1
50	Spring	1
51	Idler axle	1
52	Cap nut	2
53	Flat Washer	1
54	Plastic Washer	1
55	Flywheel Frame	1
56	Frame	1
57	Wheels	1

#	DESCRIPTION	QTY
58	Bearing	1
59	Magnet flywheelarbar	1
60	Rear stabilizer	1
61	Screw	4
62L	Rear end cap L	1
62R	Rear end cap R	1
63	Waved washer	6
64	Cap nut	4
65	Flat Washer	2
66	Spring washer	2
67	Screw	2
68	Motor	1
69	Screw	6
70	Wire	1
71	Nut	1
72	Idler	1
73	Curved washer	2
74	Spring	1
75	Idler axle	1
76	Flat washer	2
77	Anti-loose Allen Bolt	1
78	Crank tapped hole	2
79	Main post plastic cover	1
80	Belt	1
81	Anti-loose Allen Screw	3
82	φ 240 belt wheel	1
83	Pedal Axle	1
84	Washer	2
85	Screw	4
86	Flat Washer	4
87	Upper sensor cable	1

#	DESCRIPTION	QTY
88L	Front end cap L	1
88R	Front end cap R	1
89	Front stabilizer	1
90	Main post	1
91	Screw	2
92	Bottle cage	1
93	Flat Washer	1
94	Allen Key	1
95	Wrench	1
96	Adapter	1

A successful exercise program consists of a warm-up, aerobic exercise, and a cool-down. Do the entire program at least two and preferably three times a week, resting for a day between workouts. After several months, you can increase your workouts to four or five times per week.

WARMING UP

The purpose of warming up is to prepare your body for exercise and to minimize injuries. Warm up for two to five minutes before strength-training or aerobic exercising. Perform activities that raise your heart rate and warm the working muscles. Activities may include brisk walking, jogging, jumping jacks, jump rope, and running in place.

STRETCHEN

Stretching while your muscles are warm after a proper warm-up and again after your strength or aerobic training session is very important. Muscles stretch more easily at these times because of their elevated temperature, which greatly reduces the risk of injury. Stretches should be held for 15 to 30 seconds.

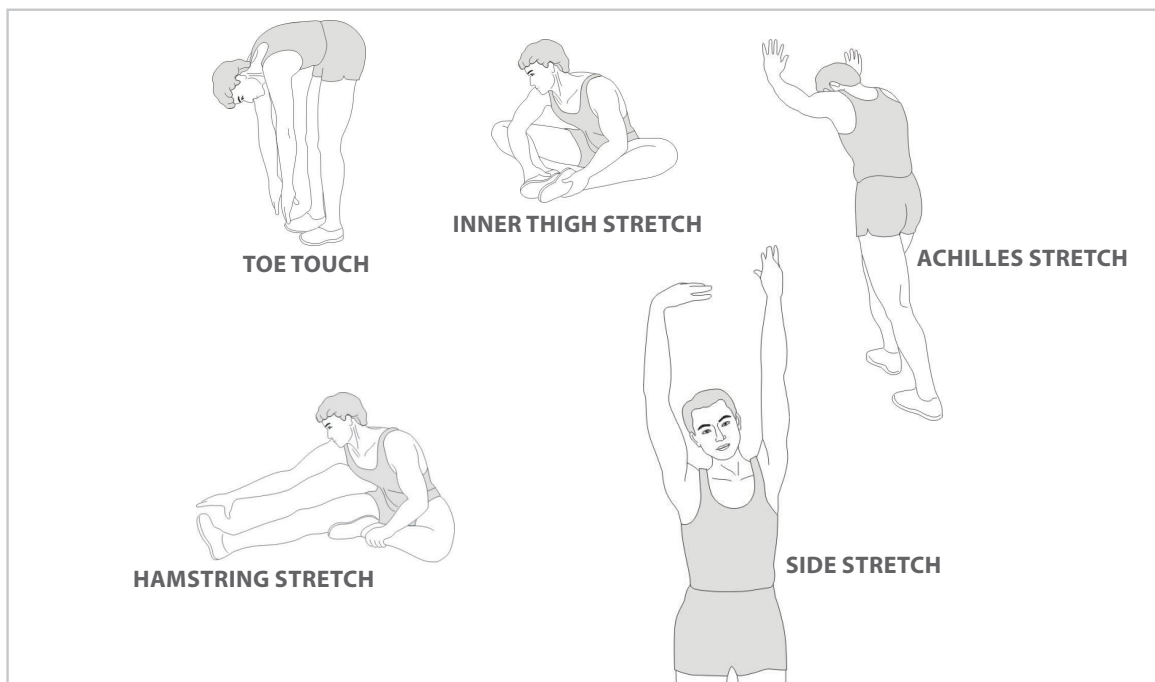

COOLING DOWN

The purpose of cooling down is to return the body to its normal or near normal, resting state at the end of each exercise session. A proper cool-down slowly lowers your heart rate and allows blood to return to the heart.

virtu profit

For questions or missing parts please contact your dealer.