

virtuafit

Elite Smart Touch Treadmill

User manual



| | |
|-----------------------|---------|
| SAFETY INSTRUCTIONS | 3 - 4 |
| CHECKLIST | 5 |
| ASSEMBLY INSTRUCTIONS | 6 - 13 |
| FOLDING INSTRUCTIONS | 14 - 15 |
| LEVELING ADJUSTMENT | 16 |
| MAINTENANCE | 17 - 18 |
| TROUBLE SHOOTING | 19 - 20 |
| CONTROL PANEL | 21 - 32 |
| APP INSTRUCTIONS | 33 |
| EXPLODED DRAWING | 34 - 35 |
| PARTS LIST | 36 - 38 |
| TRAINING INSTRUCTIONS | 39 |

WARNING:

Before beginning any exercise program consult your physician. This is especially important for people who are over 35 years old or who have pre-existing health problems. Read all instructions before using any fitness equipment. Do not operate this device without properly fitted guards, as the moving parts can present a risk of serious injury if exposed.

ATTENTION

- It is important to read this entire manual before assembling and using the device. Safe and effective use can only be achieved if the device is assembled, maintained and used properly. It is your responsibility to ensure that all users of the device are informed of all warnings and precautions.
- Before starting any exercise program, you should consult your doctor to determine if you have any medical or physical conditions that could put your health and safety at risk, or prevent you from using the device properly. Your doctor's advice is essential if you are taking medication that affects your heart rate, blood pressure or cholesterol level.
- Be aware of your body's signals. Incorrect or excessive exercise can damage your health. Stop exercising if you experience any of the following symptoms: pain, tightness in your chest, irregular heartbeat, extreme shortness of breath, lightheadedness, dizziness or feelings of nausea. If you do experience any of these conditions you should consult your doctor before continuing with your exercise program.
- Keep children and pets away from the device. The device is designed for adult use only.
- Use the device on a solid, flat level surface with a protective cover for your floor or carpet. To ensure safety, the device should have at least 0.5 metres of free space all around it.
- Before using the device, check that the nuts and bolts are securely tightened.
- The safety of the device can only be maintained if it is regularly examined for damage and/or wear and tear.

- Always use the device as indicated. If you find any defective components while assembling or checking the device, or if you hear any unusual noises coming from the device during use, stop immediately. Do not use the device until the problem has been rectified.
- Wear suitable clothing while using the device. Avoid wearing loose clothing that may get caught in the device or that may restrict or prevent movement.
- The max user weight is 150 KGS. Braking ability is independent of speed.
- The device is not suitable for therapeutic use.
- Care must be taken when lifting or moving the device so as not to injure your back. Always use proper lifting techniques and/or seek assistance if necessary.
- Please keep the space at least 1 to 2 meter at the end of base frame to escape any accidents!
- Place the device on a clean and flat surface. Do not place the device on a thick carpet.
- The device is for indoor use and not for outdoor use to prevent damage. Keep the storage location dry, clean and flat. It is forbidden to use the device for purposes other than training.
- Only use the machine in an environment with an ambient temperature between 10 °C and 35 °C. Only store the device at an ambient temperature between 5 °C and 45 °C.

Warranty claim is excluded if the cause of the defect is the result of:

- Maintenance assembly and repair work not carried out by an official dealer.
- In the event of improper use, neglect and / or poor maintenance.
- Failure to maintain the device in accordance with the manufacturer's instructions (see the enclosed manual).

TOOLKIT

When you open the carton, and you will find the below parts in the carton.

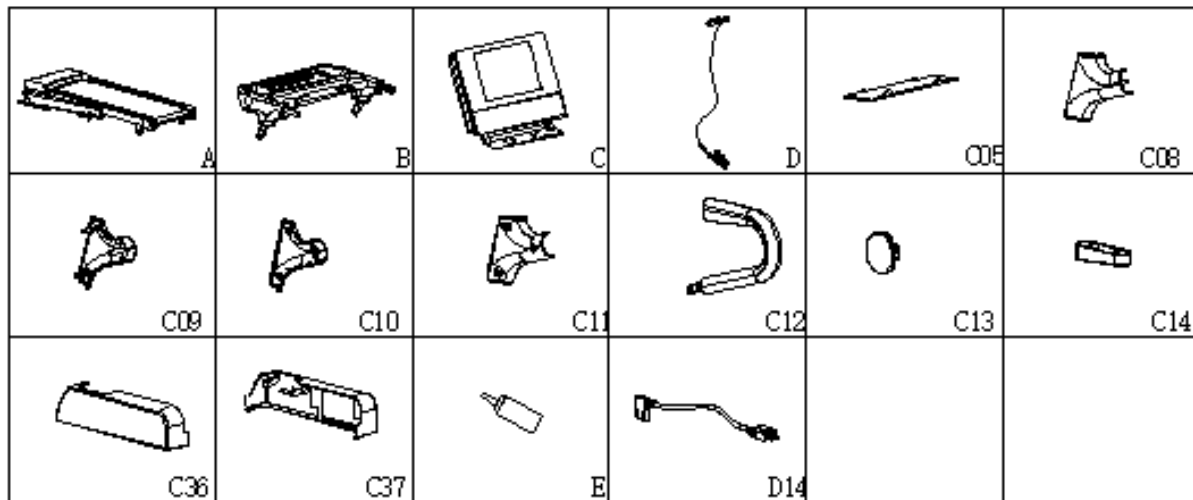

| # | DESCRIPTION | QTY | # | DESCRIPTION | QTY |
|------------|-------------------------|-----|------------|-------------------------|-----|
| A | Mainframe | 1 | C10 | Left column inner cover | 1 |
| B | Console support frame | 1 | C11 | Right cover inner cover | 1 |
| C | Console | 1 | C12 | Foam armrest | 2 |
| D | Safety key | 1 | C13 | Screw hole plug | 4 |
| D14 | Standard power cord | 1 | C14 | Armrest tube plug | 2 |
| C05 | Lower cover console | 1 | C36 | Left bottom shield | 1 |
| C08 | Left column outer cover | 1 | C37 | Right bottom shield | 1 |
| C09 | Right cover outer cover | 1 | E | Oil bottle | 1 |

ASSEMBLY TOOLS

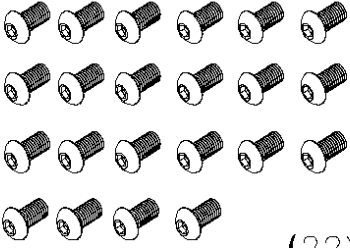
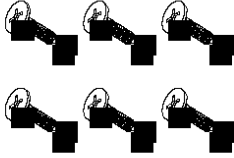
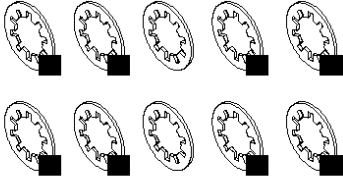
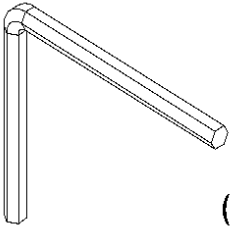
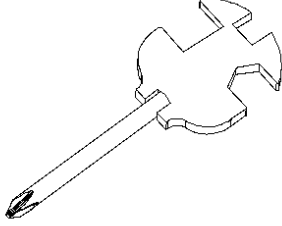
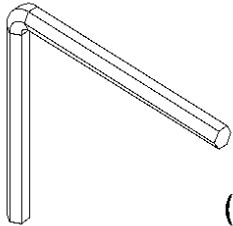
| | | |
|---|--|--|
| <p>E15 M8*15</p>  <p>(22X)</p> | <p>E24 ST4.2*15</p>  <p>(6X)</p> | <p>E32 $\varnothing 8$</p>  <p>(10X)</p> |
| <p>B07 S5</p>  <p>(1X)</p> | <p>B08 S=13 14 15</p>  <p>(1X)</p> | <p>B11 S6</p>  <p>(1X)</p> |

Missing parts: If you think you are missing certain parts in your package, carefully check the styrofoam and the device. Some parts (bolts, screws, etc.) are already attached to/in the device.

Error message: Ensure that all cables are carefully attached. The aluminum legs are very sensitive and must remain straight. Do you receive an error message after mounting your device? Then you have to straighten these aluminum legs again, this may cause the error message to disappear.

Socket screws: The device contains socket screws, make sure that the allen key is firmly in the bolt before you apply force to the key. In this way you prevent the head of the socket head screw from being rotated.

NOTE! Do not plug in the power cord until installation is complete.

STEP 1

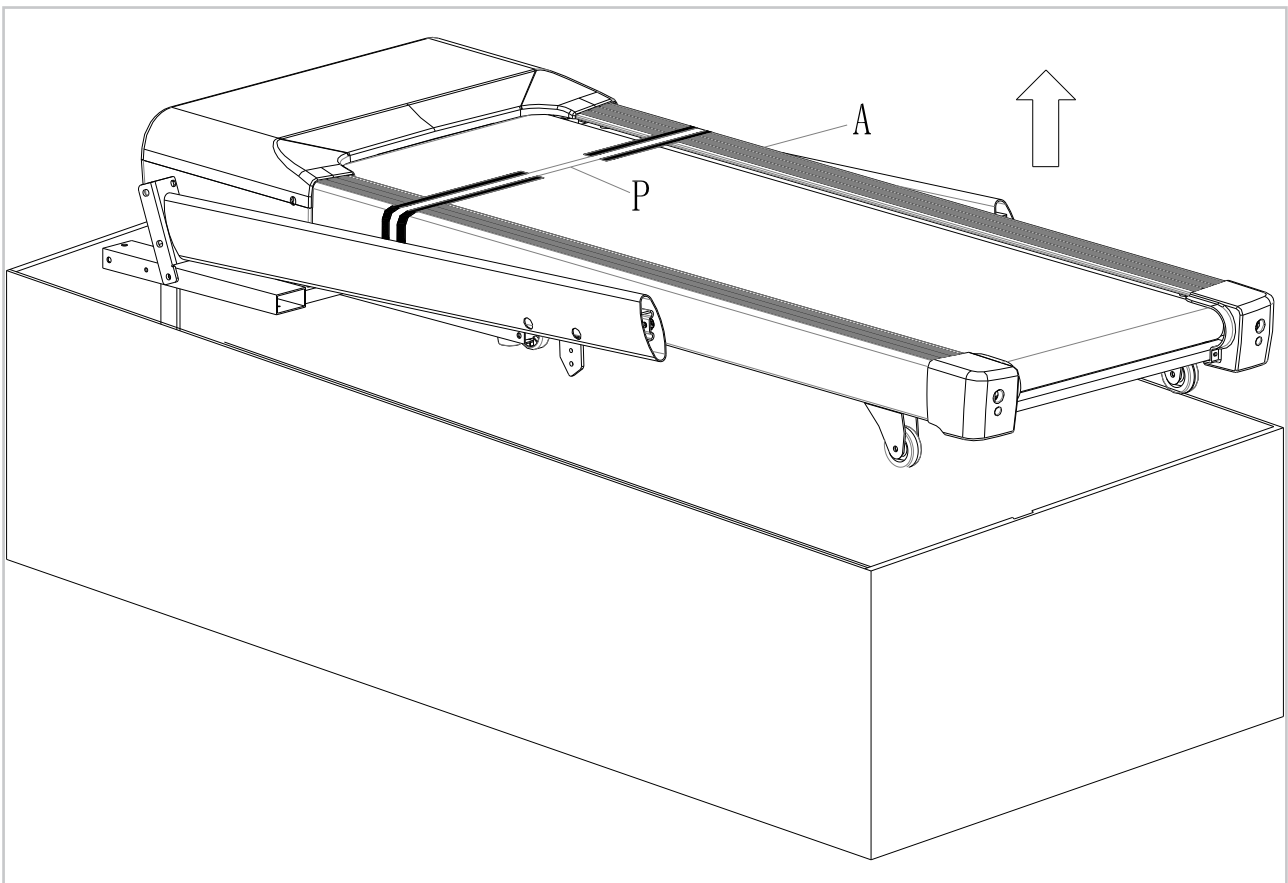

- Open the packaging and place the main frame (A) on the floor.

STEP 2



- Install the left and right uprights (A03, A04). Lift it upright as shown in the picture.
- Install the left and right uprights (A07, A08) to the main frame using the Allen key (B07) around the M8 * 15 bolt (E15) and the lock washer (E32)

STEP 3



- Now install the Display Support Frame (B).
- Connect the top cable (D09) to the bottom cable (D10). This runs out of the right upright (A04). It is important that the bakels are attached carefully.
- Use Allen key 5 (B07) and the M8 * 15 bolts (E15) to attach the support frame to the frame.
- Use sealing plug (C14) to neatly close the bolts.

STEP 4



- Install the display (C)
- Connect the cables from the display (C) to the cables from the support frame (B).

STEP 5



- Place the protective cover (C05) under the support frame (B).
- Attach the display (C) to the support frame (B). To do this, use Allen key 5 (B07) and the and M8 * 15 bolts (E15) with the corresponding lock washers (E32).

STEP 6



- Place the left and right hand rests (C12)
- Use Allen key 5 (B07) and the and M8 * 15 bolts (E15) to attach the palm rests to the support frame.
- Close the bolts with the corresponding blanking plugs (C15)

STEP 7



- Attach the upright cover (E24)
- Use the Phillips screwdriver (B08) and the screws (E24) to attach the cover.

STEP 8

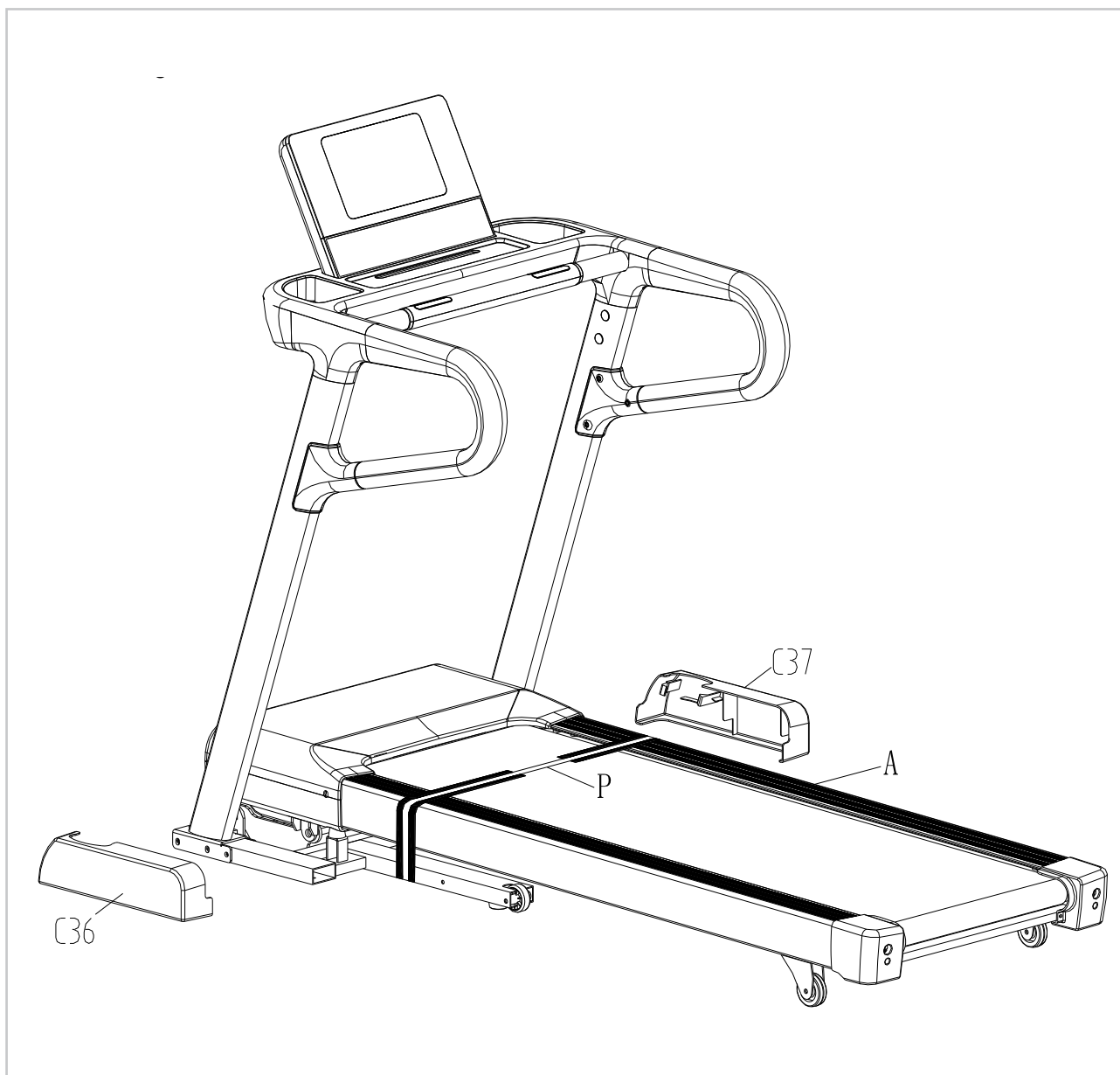

- Attach the left and right guards. (C36, C37).

STEP 9



- Cut the packing strap (P).

STEP 10



- Use the Allen key 5 (B07) and loosen the M8 * 15 bolt to remove the f-module (G).

ATTENTION

- **When using the treadmill, always go before the treadmill rolls on the rails stand. Once the tire rolls, you can stand on the walking platform. In this way, the engine least loaded.**
- **After using the treadmill, turn off the power switch (on / off). In addition, do not use the emergency stop unnecessary, only in an emergency. In this way, the circuit board is least loaded.**

SAFETY KEY



- Install the safety key in the console.
- When you start walking, attach the safety key to your clothing. Pull at one emergency on the key safety lanyard and the treadmill will stop immediately.

NOTE! Store your machine in a dry area away from children and high traffic areas as shown in the illustration. Be sure it is secure and cannot fall onto small animals or children.

FOLDING

Hold the treadmill by the end. Push the treadmill up until you hear a click of the gas spring.

NOTE! Do not fold the treadmill while it is in use.

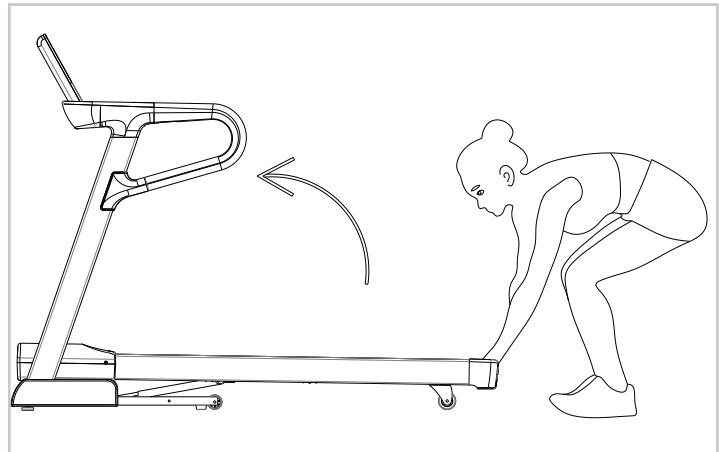

UNFOLDING

Hold the treadmill by the end. Press against the gas spring with your foot. Press down on the walking platform and pull your foot away. The walking platform will then lower automatically.

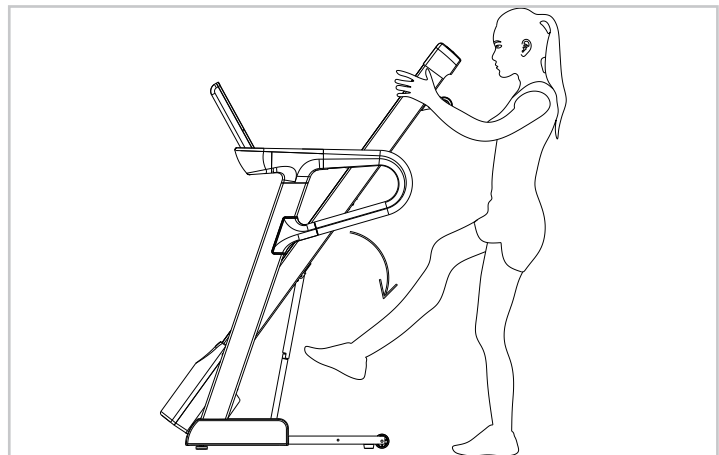

MOVING THE TREADMILL

Before you can move the treadmill, it must be folded.

Hold the walking platform firmly, step on one of the wheels with your foot.

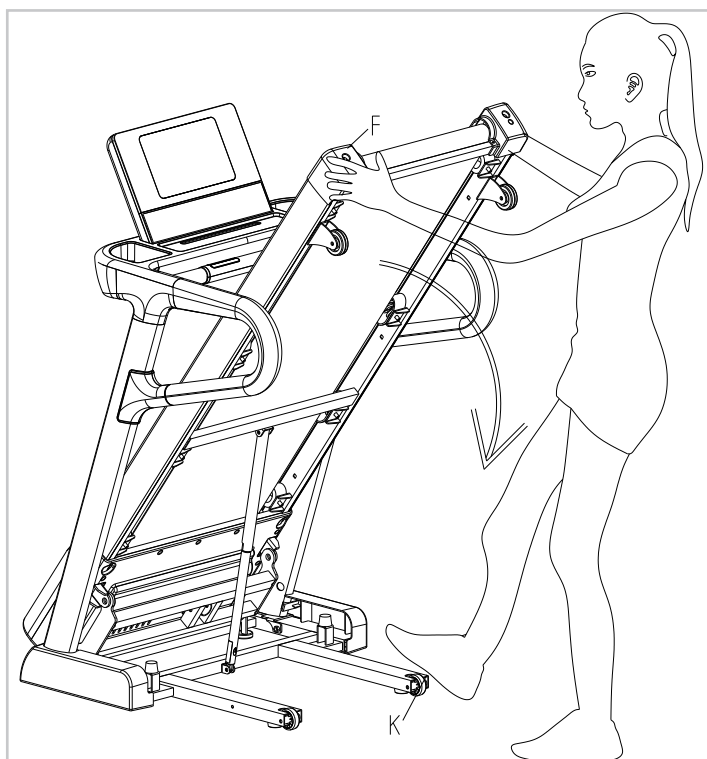

Push the walking platform down until the transport wheels are both on the ground. From this moment on, the treadmill can be moved.

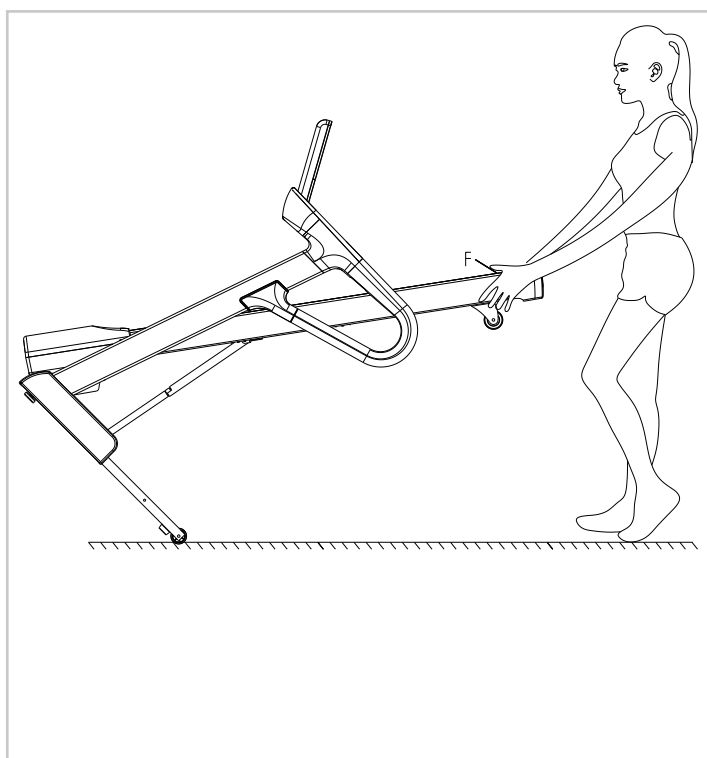

LEVELING THE TREADMILL

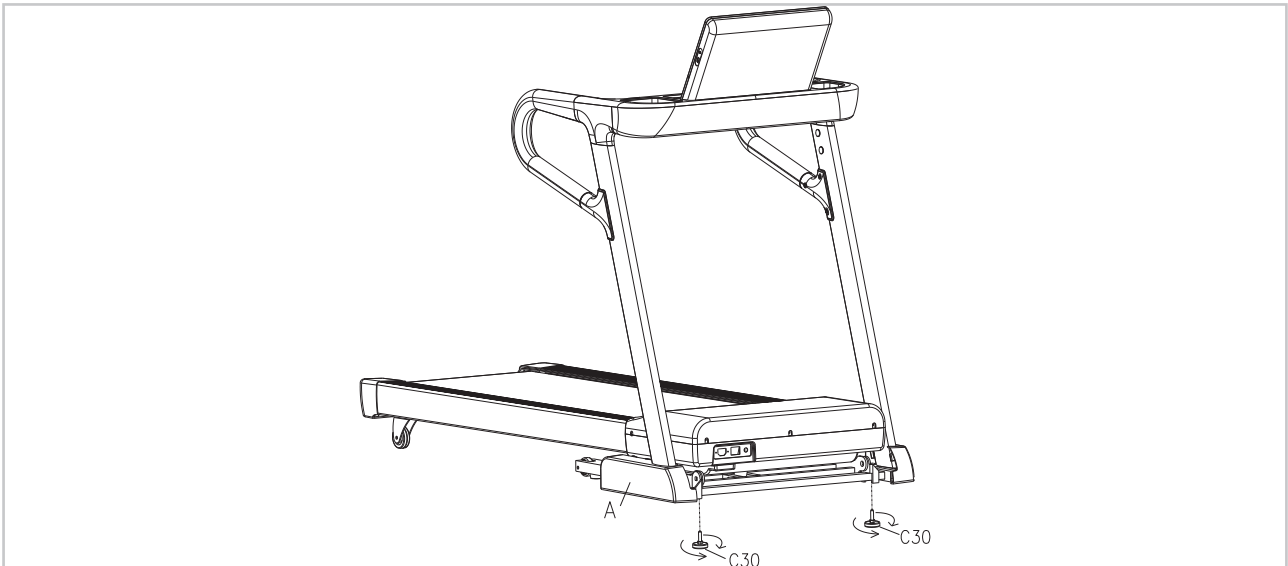

The treadmill has passed the evenness test before leaving the factory. If the floor is uneven, please adjust knob C30 in the figure.

RUNNING BELT ADJUSTMENT

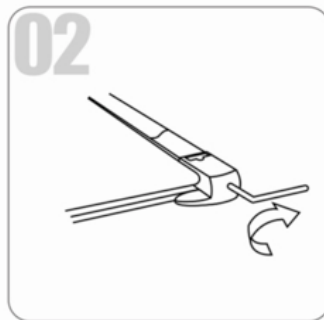
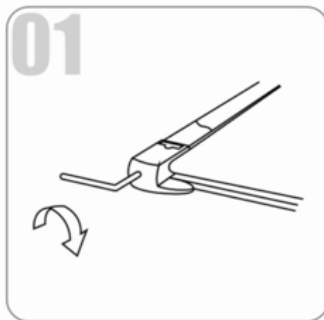

01. Running belt deviates to left: Start the machine, set speed at 2-3 km/h without a load on the belt, use Allen key to turn the screw 1/4 turn (see fig. 1). Then allow the machine to run without a load for 1-2 minutes. Repeat process until the belt becomes central.

02. Running belt deviate to right: Start the machine, set speed at 2-3 km/h without a load on the belt, use Allen key to turn the screw 1/4 turn (see fig. 2). Then allow the machine to run without a load for 1-2 minutes. Repeat process until the belt becomes central.

03. Running belt jam: If the running belt is in dead condition, use the Allen key to turn the screw 1/2 a turn both left and right until the jam solved (see fig 3).

Safe and effective use can only be achieved if the device will be assembled and maintained well. It is your responsibility to ensure that the equipment is regularly maintained. Parts that are already used and / or damaged must be replaced before continuing using. The rower machine may only be used indoors and stored away, prolonged exposure to weathering and changes in temperature / humidity can have a serious impact on the electrical components and moving parts of the device.

DAILY MAINTENANCE

- Clean and remove sweat after each use Do not use aggressive cleaning agents and ensure that the device remains free of moisture.
- Check that the rail and the wheels under the seat are free from dust and dirt.

SEMI-ANNUAL MAINTENANCE

- Inspect all bolts and nuts in connection with moving parts of the device, tighten as required.
- Check the mobility of moving parts and components of the use equipment, silicone spray if necessary.

CLEANING

Before cleaning the machine, please make sure the power has been switched off.

Cleaning: General cleaning of the device will extend the life of the treadmill. Hold clean the treadmill by dusting regularly. Be sure to clean the exposed area of the belt and the foot rails of the treadmill on both sides.

In addition, wear clean shoes to reduce the risk of contamination of the treadmill. Remove the hood at least once a year to vacuum underneath.

For more information: www.virtufit.nl/service/faq/#toggle-id-1

LUBRICATING THE BELT

This treadmill is equipped with a pre-lubricated, low maintenance deck system. The belt/ deck friction may play a major role in the function and life of your treadmill, thus requiring periodic lubrication. We recommend a periodic inspection of the deck. You need contact with our service center if you find the damage of the deck.

We recommend lubrication of the deck according to the following timetable:

- **Light user** (less than 3 hours/ week) annually
- **Medium user** (3-5 hours/ week) every six months
- **Heavy user** (more than 5 hours/ week) every three months

Best indicator is to lubricate when the walking platform feels dry. We recommend that you buy the lubrication from our distributor or directly to our company.

NOTE! *Any repair need the professional technician.*

- We suggest that you should cut off the power for 10 minutes after keep running 2 hours, so that it's good for maintain the treadmill.
- For avoiding the slipping during running, the belt not too loose; for avoiding the more abrasion between the roller and belt and maintain the machine's good running ,the belt not too tight. You can adjust the distance between plates and belt, the belt be away from the plates about 50-75 mm on both sides, if the best not too tight and loose.

We strongly recommend that you do the following

- Switch off and remove the power cable from the wall after every use, especially if children are present.
- Clean your treadmill after use.
- Use a dry cloth to clean the control panel and areas around the power switch. Use a soft clean cloth and cleanser to remove stubborn stains and dirt off the running belt.
- Tighten the running belt once a month.
- Keep your treadmill in a safe dry place away from heat and water.

USAGE OF SILICONE OIL

Pull up tightly of the running belt. Then put the silicone oil to running board. Then start the machine to running 3 minutes without loading. It is better to maintain like this every 30 hours working of the machine. This can save lifetime of parts properly.

**We recommend that you do the following:**

- Disconnect the power cord after every use, especially when children are present.
- Clean the treadmill after use.
- Use a dry cloth to cover the control panel and areas around the on/off switch clean.
- Use a soft clean cloth and detergent to remove stubborn stains and dirt from the treadmill.
- Tighten the treadmill once a month.
- Keep your treadmill away from heat and water in a safe, dry place.

Regular maintenance prolongs the life of your treadmill and prevents injury!

ERROR CODES

Communication error

- Ensure the main wires are connected well.
- Replace the main wire.
- Replace the controller.
- Replace the driver.

Stall protection

- Ensure the motor wires are connected well.
- Replace the motor.
- Replace the driver.

No speed sensor signal

- Ensure the speed wires are connected well.
- Replace the speed wire.
- Replace the driver.

Incline study fail

- Ensure the incline wires are connected well.
- Replace the incline motor.
- Replace the driver.

Overcurrent protection

- Lighten the load.
- Check transmission parts, add lubricating oil.
- Replace the motor.
- Replace the driver.

Motor break

- Ensure the motor wires are connected well.
- Replace the motor.

Storage fault

- Check 24C02.
- Replace the motor.

Location fault

- Put the treadmill horizontally.
- Replace the driver.

Moment overcurrent

- Replace the motor.
- Check transmission parts, add lubricating oil.

Overvoltage

- Stop use, check external wire.

undervoltage

- Stop use, check external wire.









CONSOLE







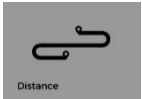



FUNCTION

| | |
|--------------------|---|
| INCLINE +/- | Adjustable range is 0-15 segments. The adjustment range is 1 segment/time. When it is continuously pressed for more than 0.5 seconds, it will automatically continue to increase or decrease. |
| SPEED +/- | Adjustable range is 0.8-18 km/h. The adjustment range is 0.1 km/time, and when it is continuously pressed for more than 0.5 seconds, it will automatically continue to increase or decrease. |
| HOME | You can return to the home screen from any screen (except the homescreen). |
| START/STOP | When the power is turned on and the safety lock is engaged, you can press this button at any time to start or stop the treadmill. If it starts in manual mode, the treadmill will start running at the lowest speed and lowest incline. |
| BACK | It can return to the previous screen. |

FUNCTIONS

| FUNCTION | |
|---|--|
| 19:25 02/08/2019 | Time and date: When the device is connected to the Internet, they will be automatically calibrated. |
|  | Heart rate: When the device detects the heart rate, this icon will be lighted ON (if the device is equipped with a wireless chest belt, the heart rate data from the wireless chest belt will be displayed in priority). |
|  | Bluetooth: This icon will be lighted ON when the device is connected to the APP. |
|  | Wi-Fi: This icon will be lighted ON when the device is connected to the Wi-Fi. |
|  | Volume adjustment: Adjust the volume by scrolling. |
|  | Settings. |
|  Runner 1 Let's start! | Current user name. |
|  | User quick switch. |
|  | Distance countdown. |
|  | Time countdown. |
|  | Calories countdown. |

FUNCTIONS

| FUNCTION | |
|---|---|
|  | Steps countdown. |
|  | Start up. |
|  | Built-in HRC, Runway, Workout Programs. |
|  | Built-in user information settings, My Reports, My Programs, My Test. |
|  | Scene training mode. |
|  | Local music, video file management and playing. |
|  | Third-party APP. |
|  | User's manual. |
|  | Return. |
|  | Homepage. |

ATTENTION

- *To ensure the normal operation of the treadmill, please do not download other software.*
- *In order to ensure the operating speed of the treadmill, please clear its cache regularly.*
- *The treadmill maybe cannot connect to Wi-Fi that requires web authentication.*
- *When using the treadmill for the first time, please register your personal account first, so that you can better experience the powerful functions of PRM (The Professional Running Manager).*

MAIN INTERFACE

START-UP

- Check that the safety key is properly configured, and turn on the power switch.
- After startup, the screen displays the buffer interface, and then enter the main interface when the progress bar is 100%.

QUICK START

After clicking "START", the device will start up at the lowest speed and incline. As required, click "SPEED + / SPEED -" to change the speed; click "INCLINE ▲ / INCLINE ▼ " to change the incline.

DISTANCE COUNTDOWN

- After clicking this icon, there will be five system modes (5 KM, 10 KM, 15 KM, Half Marathon, Marathon) and other custom modes (Customize) available.
- After setting, click "START" to start the exercise. (As required, click "SPEED + / SPEED -" to change the speed; click "INCLINE ▲ / INCLINE ▼ " to change the incline.)
- Click "PAUSE" to pause the exercise; click "STOP" to stop the exercise, and automatically display its related data records.

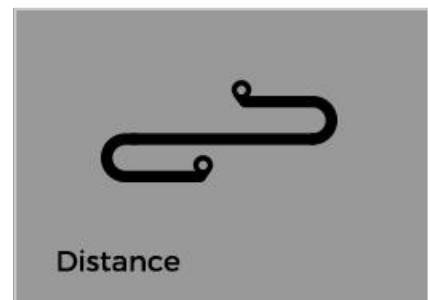

TIME COUNTDOWN

- After clicking this icon, there will be five system modes (10 MIN, 20 MIN, 30 MIN, 40 MIN, 60 MIN) and other custom modes (Customize) available.
- After setting, click "START" to start the exercise. (As required, click "SPEED + / SPEED -" to change the speed; click "INCLINE / ▲ INCLINE ▼ " to change the incline.)
- Click "PAUSE" to pause the exercise; click "STOP" to stop the exercise, and automatically display its related data records.



CALORIE COUNTDOWN

- After clicking this icon, there will be five system modes (150 KCAL, 300 KCAL, 500 KCAL, 800 KCAL, 1000 KCAL) and other custom modes (Customize) available.
- After setting, click "START" to start the exercise. (As required, click "SPEED + / SPEED -" to change the speed; click "INCLINE / ▲ INCLINE ▼" to change the incline.)
- Click "PAUSE" to pause the exercise; click "STOP" to stop the exercise, and automatically display its related data records.

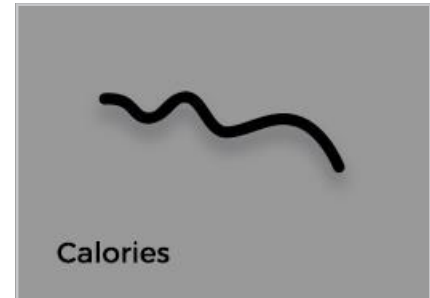

STEPS COUNTDOWN

- After clicking this icon, there will be five system modes (1 KILOSTEPS, 2 KILOSTEPS, 5 KILOSTEPS, 8 KILOSTEPS, 10 KILOSTEPS) and other custom modes (Customize) available.
- After setting, click "START" to start the exercise. (As required, click "SPEED + / SPEED -" to change the speed; click "INCLINE / ▲ INCLINE ▼" to change the incline.)
- Click "PAUSE" to pause the exercise; click "STOP" to stop the exercise, and automatically display its related data records.

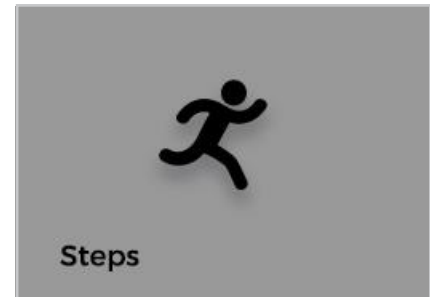

PROGRAMS

HRC

NOTE! To better experience this function, it is recommended to be equipped with both wireless heart rate receiver and chest belt.

1. Click "HRC".
2. Set the parameters as required. After setting, click "START" to start the exercise.

NOTE! Age cannot be set here, which needs to be set/modified in the user information.

3. As required, click "SPEED + / SPEED -" to change the speed; click "INCLINE ▼ / INCLINE ▲" to change the incline.

NOTE! The pink line represents the maximum heart rate, the blue line represents the target heart rate, and the red line represents the user's real-time heart rate.

4. Click "PAUSE" to pause the exercise; click "STOP" to stop the exercise, and automatically display its related data records.

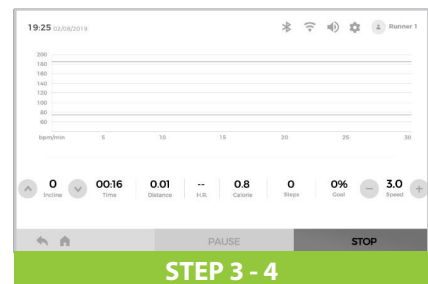
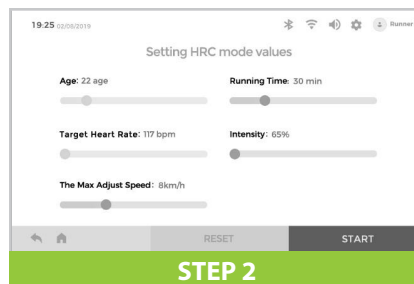
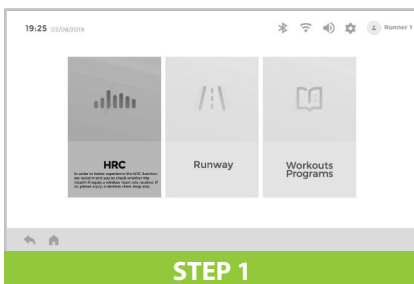

RUNWAY

1. Click "RUNWAY".
2. Set the number of circles as required (400m / circle). After setting, click "START" to start the exercise
3. After the runway is lighted ON for one circle, the number of completed circles is 1; but if the exercise is less than one circle, it will not be counted.
4. As required, click "SPEED + / SPEED -" to change the speed; click "INCLINE ▼/ INCLINE ▲" to change the incline. Click "PAUSE" to pause the exercise; click "STOP" to stop the exercise, and automatically display its related data records.

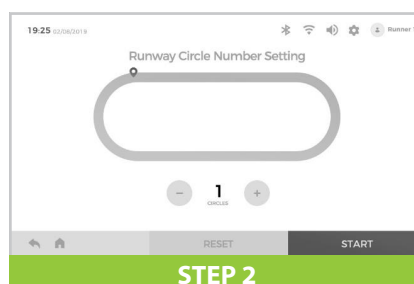
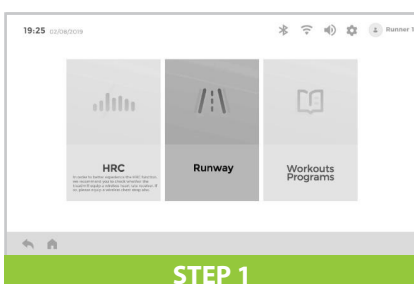

WORKOUT PROGRAMS

1. Click "WORKOUT PROGRAMS".
2. Touch lightly the line of "P1-P14", and scroll it left and right, then click to select the training program as required. When the name is lighted ON, the program is selected; the bar chart displays the segmented data of Speed and Incline.
3. Set the exercise time. After setting, click "START" to start the exercise.
4. As required, click "SPEED +/SPEED -" to change the speed; click "INCLINE ▼ / INCLINE ▲" to change the incline.
5. Click "PAUSE" to pause the exercise; click "STOP" to stop the exercise, and automatically display its related data records.

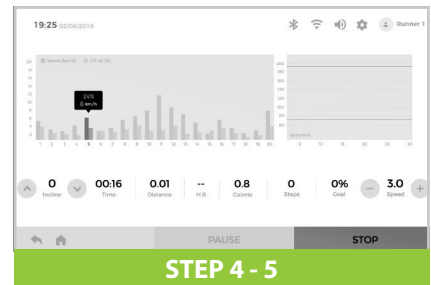
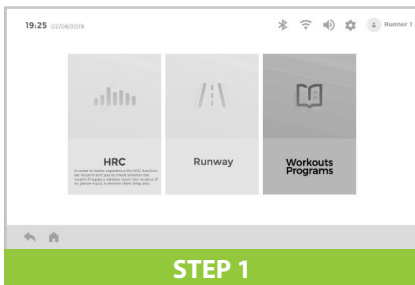

Speed and Incline segmented change curves for P1-P36 programs.

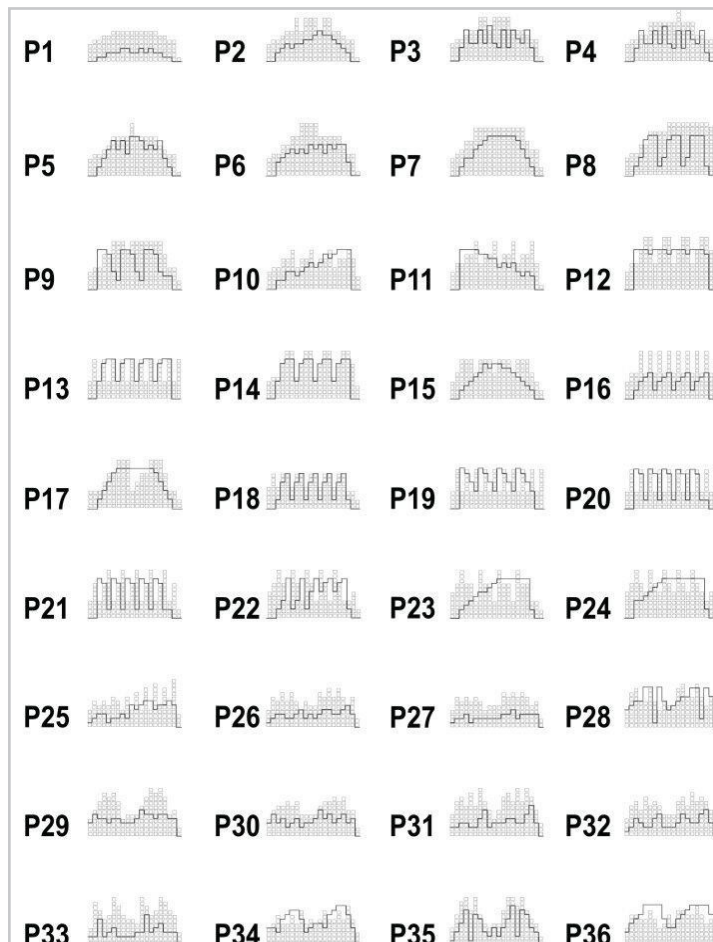

MY TRAINING

Register and modify the user information.

1. Register a new user: Click “EDIT”.
2. Registered users: To confirm whether the current user name is correct, you can click “Switch User” to switch the users; to modify the current user information, you can click “Edit”.
3. Click “Edit Information”.
4. Fill in the information, and then click “Next” to return to the previous interface.

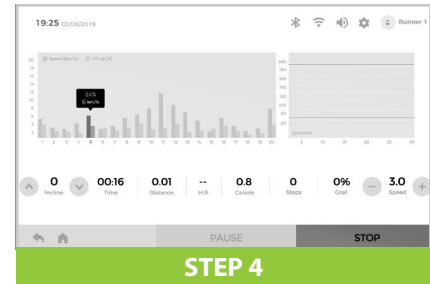
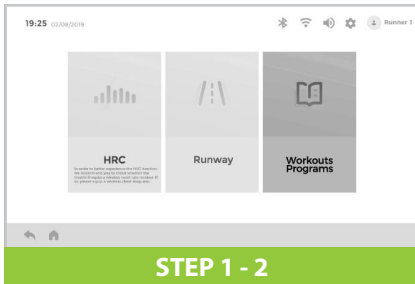

MY REPORTS

1. Click “MY REPORTS”.
2. Display the current user’s total exercise data.
3. Click “CLEAR DATA” to clear the data.

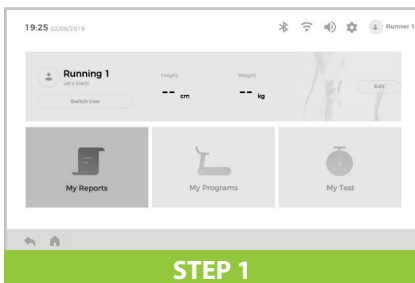

MY PROGRAMS

1. Click “MY PROGRAMS”.
2. Click “Speed” or “Incline” and scroll the circular slider to set the corresponding segmented value of “Speed” or “Incline”.
3. Set the exercise time. After setting, click “START” to start the exercise.
4. Each user can set 6 custom programs.
5. As required, click “SPEED +/SPEED -” to change the speed; click “INCLINE ▼ / INCLINE ▲” to change the incline.
6. Click “PAUSE” to pause the exercise; click “STOP” to stop the exercise, and automatically display its related data records.

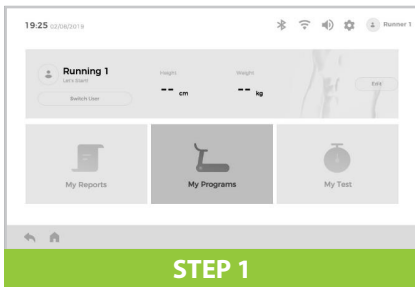

MY TEST - FITNESS TEST PRO

1. Click "MY TEST".
2. Click "FITNESS TEST".
3. Choose "PRO" (3) or "HRC" (4).
4. "PRO": Confirm the user information; if there is an error, please go to the user information to modify it, or switch the users. After setting, click "START" to start the test.
 - a. As required, click "SPEED + / SPEED -" to change the speed; click "INCLINE ▼ / INCLINE ▲" to change the incline.
 - b. After the 15-minute test, automatically display the rating results of the current test.

NOTE! During test, if clicking "STOP" to stop it, the test will not be completed, and there will be no rating results.

3. "HRC": Set the parameters as required. After setting, click "START" to start the test.

NOTE! To better experience this function, it is recommended to be equipped with both wireless heart rate receiver and chest strap. Age cannot be set here, which needs to be set/modified in the user information.

- a. As required, click "SPEED +/SPEED -" to change the speed; click "INCLINE ▼ / INCLINE ▲" to change the incline.
- b. After the 15-minute test, automatically display the rating results of the current test.

NOTE! During test, if clicking "STOP" to stop it, the test will not be completed, and there will be no rating results.

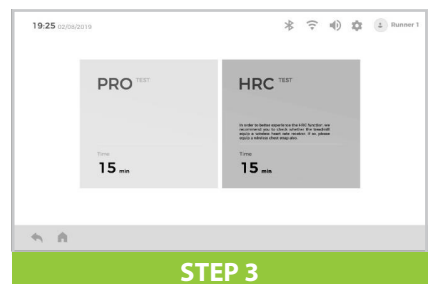
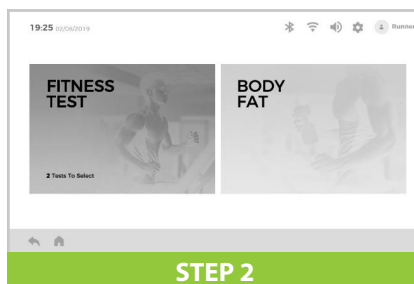
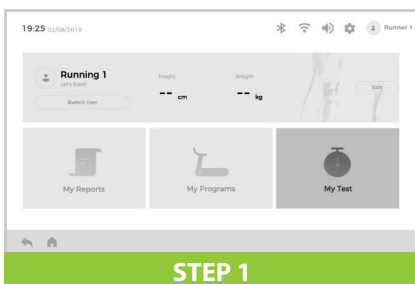

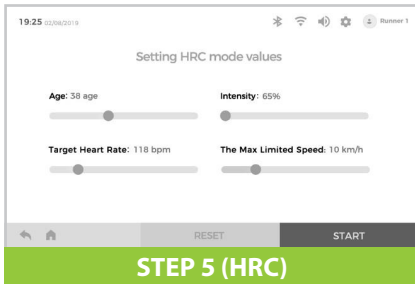
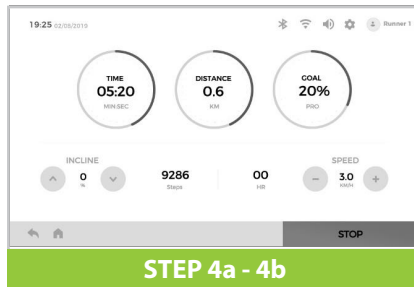

The formula for the result is $V02=(D12-504.9)/44.73$. V02 is test result and D12 is the distance that run in 12 minutes.

| | Age | V02MAX (ml/min/kg) | | | | |
|--------|-------|--------------------|---------|---------|---------|-----------|
| Male | 20-29 | V<38 | 38≤V<42 | 42≤V<46 | 46≤V<51 | V≥51 |
| | 30-39 | V<37 | 37≤V<41 | 41≤V<44 | 44≤V<48 | V≥48 |
| | 40-49 | V<35 | 35≤V<38 | 38≤V<42 | 42≤V<46 | V≥46 |
| | 50-59 | V<32 | 32≤V<36 | 32≤V<39 | 39≤V<43 | V≥43 |
| | 60-69 | V<29 | 29≤V<32 | 32≤V<36 | 36≤V<40 | V≥40 |
| | 70-79 | V<26 | 26≤V<29 | 29≤V<32 | 32≤V<37 | V≥37 |
| Female | 20-29 | V<32 | 32≤V<36 | 36≤V<40 | 40≤V<44 | V≥44 |
| | 30-39 | V<31 | 31≤V<34 | 34≤V<38 | 38≤V<42 | V≥42 |
| | 40-49 | V<29 | 29≤V<33 | 33≤V<36 | 36≤V<40 | V≥40 |
| | 50-59 | V<27 | 27≤V<30 | 30≤V<33 | 33≤V<37 | V≥37 |
| | 60-69 | V<25 | 25≤V<27 | 27≤V<30 | 30≤V<33 | V≥33 |
| | 70-79 | V<24 | 24≤V<26 | 26≤V<28 | 28≤V<31 | V≥31 |
| Class | | Fail | Pass | Good | Great | Excellent |
| Result | | E | D | C | B | A |

MY TEST - BODY FAT

1. Click "MY TEST".
2. Click "BODY FAT".
3. Set the tester information. After setting, click "Next".
4. Keep your hands holding the hand pulse sheet, the window will display your body fat index in 8 seconds.

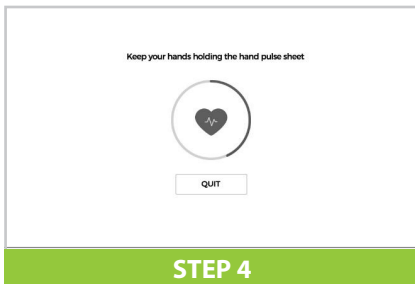
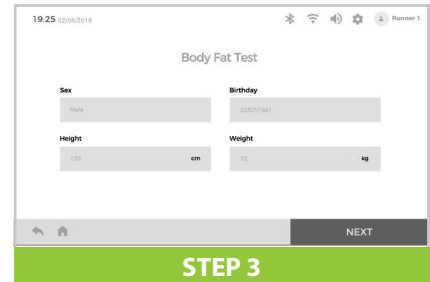
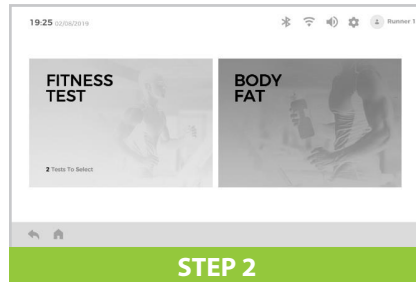
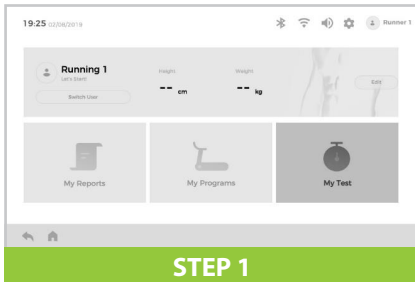

| | |
|-------------|--------|
| < 19 | THIN |
| = (20 - 25) | NORMAL |
| = (26 - 29) | WEIGHT |
| > 30 | FAT |

VIRTUAL TRAINING

1. Scroll left and right to select the desired scene, and then click "START" to start the exercise.
2. As required, click "SPEED + / SPEED -" to change the speed; click "INCLINE ▼ / INCLINE ▲" to change the incline.
3. Click "▼" at the bottom left to switch to full-screen mode, and click "▲" at the bottom right to switch to the original state.
4. Click "PAUSE" to pause the exercise; click "STOP" to stop the exercise, and automatically display its related data records.



VIDEO

Manage and play the audio and video files built in the device or inside USB, and support to play the files in MP3, APE, MP4, MOV and other common audio and video formats.

1. Click "VIDEO".
2. Select the video file that you want to watch.
3. Click "START" to start the exercise.

NOTE! *When the video is playing, the user can click " " to zoom out the video to a compact window (or choose whether to click " * " to pause the video playing). At this time, the user can operate other functions of the device.*

4. As required, click "SPEED + / SPEED -" to change the speed; click "INCLINE ▼ / INCLINE ▲" to change the incline.
5. Click "▼" at the bottom left to switch to full-screen mode, and click "▲" at the bottom right to switch to the original state.
6. Click "PAUSE" to pause the exercise; click "STOP" to stop the exercise, and automatically display its related data records.
7. After these operations are completed, click the compact window to switch to the interface of video playing.

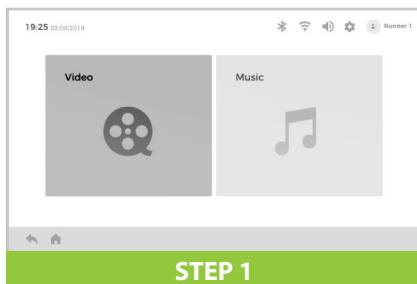

STEP 1

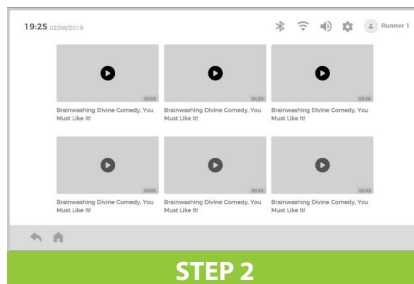

STEP 2

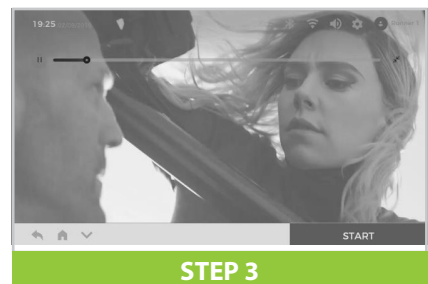

STEP 3

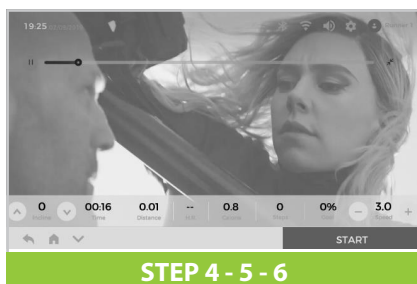

STEP 4 - 5 - 6

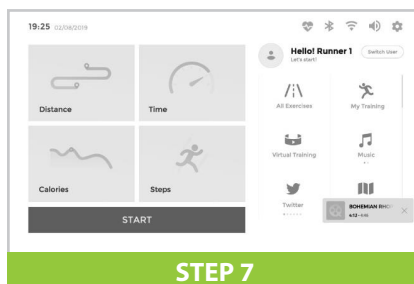

STEP 7

MUSIC

Manage and play the audio and video files built in the device or inside USB, and support to play the files in MP3, APE, MP4, MOV and other common audio and video formats.

1. Click "MUSIC".
2. Select the audio file that you want to play.
3. After clicking the playlist "", the user can select some music files to play. After "" or "" is lighted ON, the user can change the order in which audio files are played.
4. Click "START" to start the exercise.

NOTE! After clicking the playlist "≡", the user can select some music files to play. After "⌂" or "↺" is lighted ON, the user can change the order in which audio files are played.

5. As required, click "SPEED +/SPEED -" to change the speed; click "INCLINE ▼ / INCLINE ▲" to change the incline.
6. Click "PAUSE" to pause the exercise; click "STOP" to stop the exercise, and automatically display its related data records.
7. After these operations are completed, click the compact window to switch to the interface of music playing.

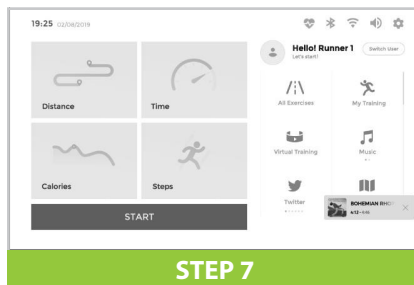
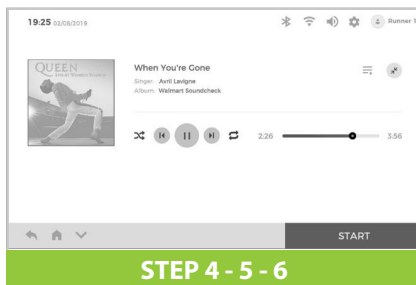
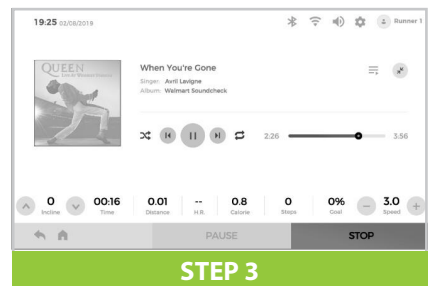
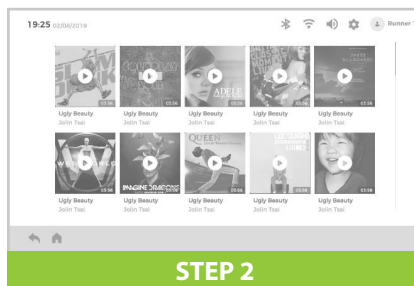
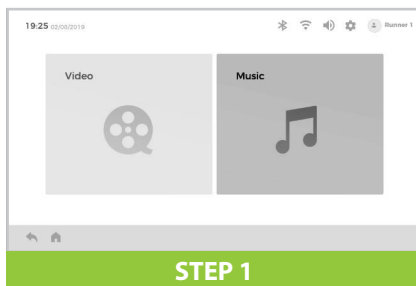

APPLICATION

Built-in third-party Apps: YouTube, Amazon Music, Instagram, Twitter, Chrome, Netflix, Spotify, Facebook and Prime Video.

Due to different laws of network management in different regions, some APP functions may not be used. When using, it needs to be connected to Wi-Fi. Try not to use the APP during exercise, so as to avoid any accidental injury caused by distraction.

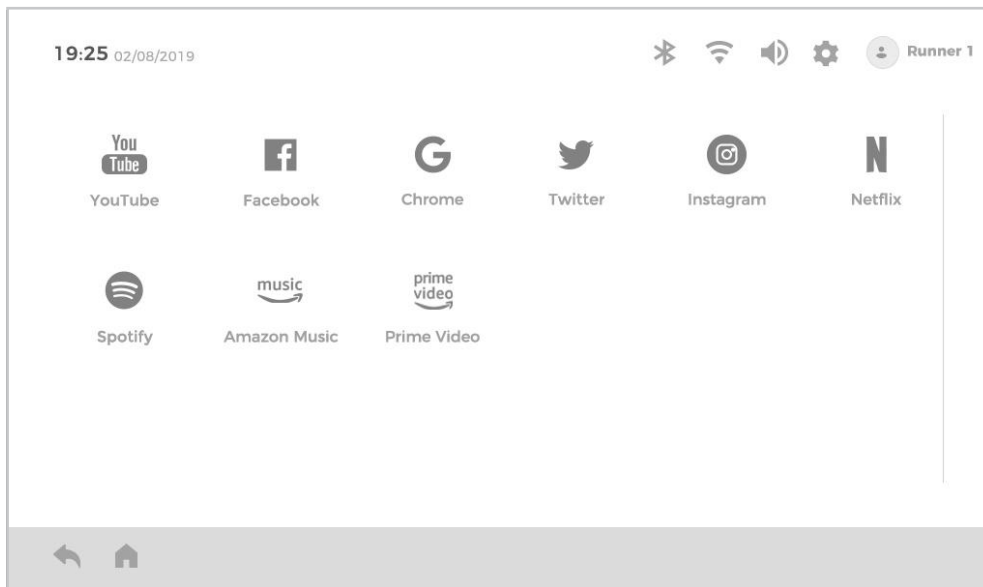

GUIDE ME

It is recommended to read Instruction and Prompt in Guide Me before exercise.

SETTING

- **Wi-Fi**
Switch on the Wi-Fi signal, scroll up and down the Wi-Fi list, and click the name of the Wi-Fi to be connected, then enter the password to connect it.
- **Display & Brightness**
Scroll up and down to adjust the screen brightness.
- **Language**
Scroll up and down the language list, and then click to select the desired language.
- **Unit Change**
Switch between metric system and British system.
- **Time Setting**
Click to select the time zone that you are located in.
- **Clear Cache**
It is recommended that the cache be cleaned monthly.

SAFETY KEY

Pull off the safety key in any time the machine will stop immediately. Meanwhile all window shows "----" and the beeper alarms. To start the treadmill again, insert the magnet end of Safety Key into the console and press "START".

USB CHARGING

You can charge your electronic devices during exercise through the USB slot.

MP3

You can connect your mobile phone with MP3 wire to play music, choose music and adjust the volume of music by your mobile phone buttons.

ATTENTIONS

- 1. Please check the power and the safety key are well or not before training.**
- 2. If any accident happened during exercise, please pull off the safety immediately until it stop.**
- 3. If there is something wrong with the machine, please connect the retailer as soon as possible.
It`s not allowed to repair the equipment by layperson.**
- 4. You can pull off the plug from the socket anytime, and this will not do damage to the treadmill.**

INSTRUCTION

1. QR code scanner app is required to scan the QR code with an Android or IOS phone or tablet. This app can be downloaded in the App Store or Google Play Store.
2. Scan one of the QR codes below to go directly to the place in the App Store or Google Play Store where the app is located and can be downloaded.
3. Scan the QR code on the right to go to the user manual of the app. The manual describes step by step how the app should be connected to the device, how the app works and what the options are.

ZWIFT

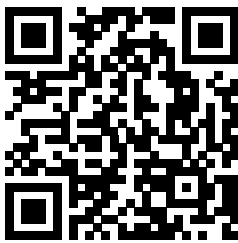

APP STORE
ZWIFT



GOOGLE PLAY
ZWIFT



USER MANUAL
ZWIFT

FITSHOW

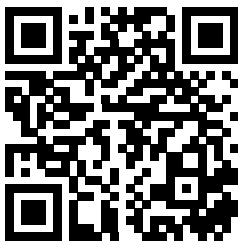

APP STORE
FITSHOW

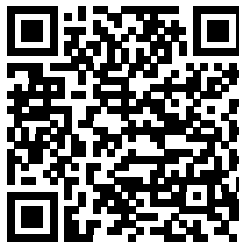

GOOGLE PLAY
FITSHOW

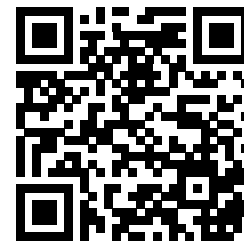

USER MANUAL
FITSHOW

VirtuFit does not provide service for third-party fitness apps such as Kinomap, iConsole, FitShow etc.. If you encounter any troubles with a third-party fitness app, please contact the app developer.

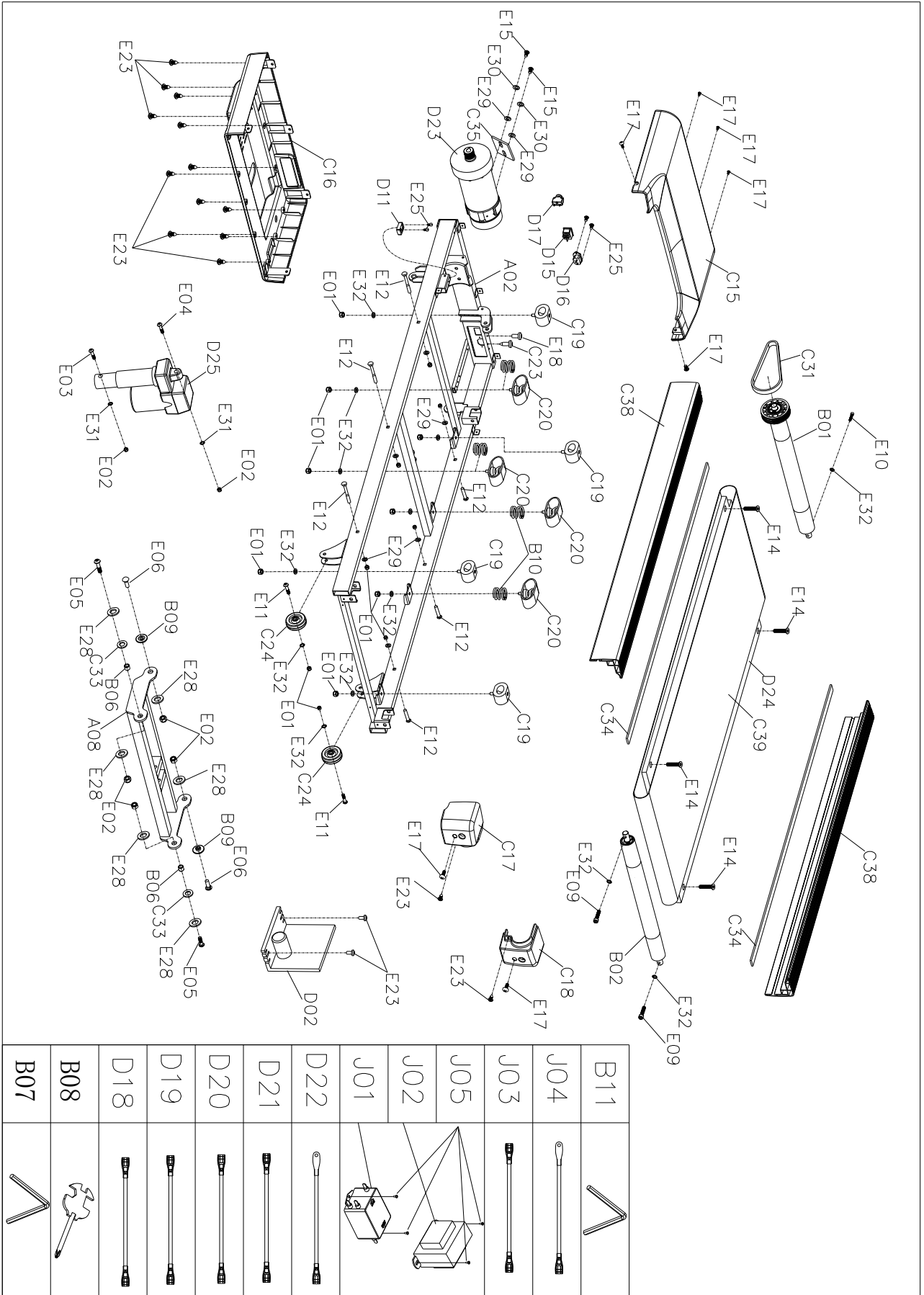

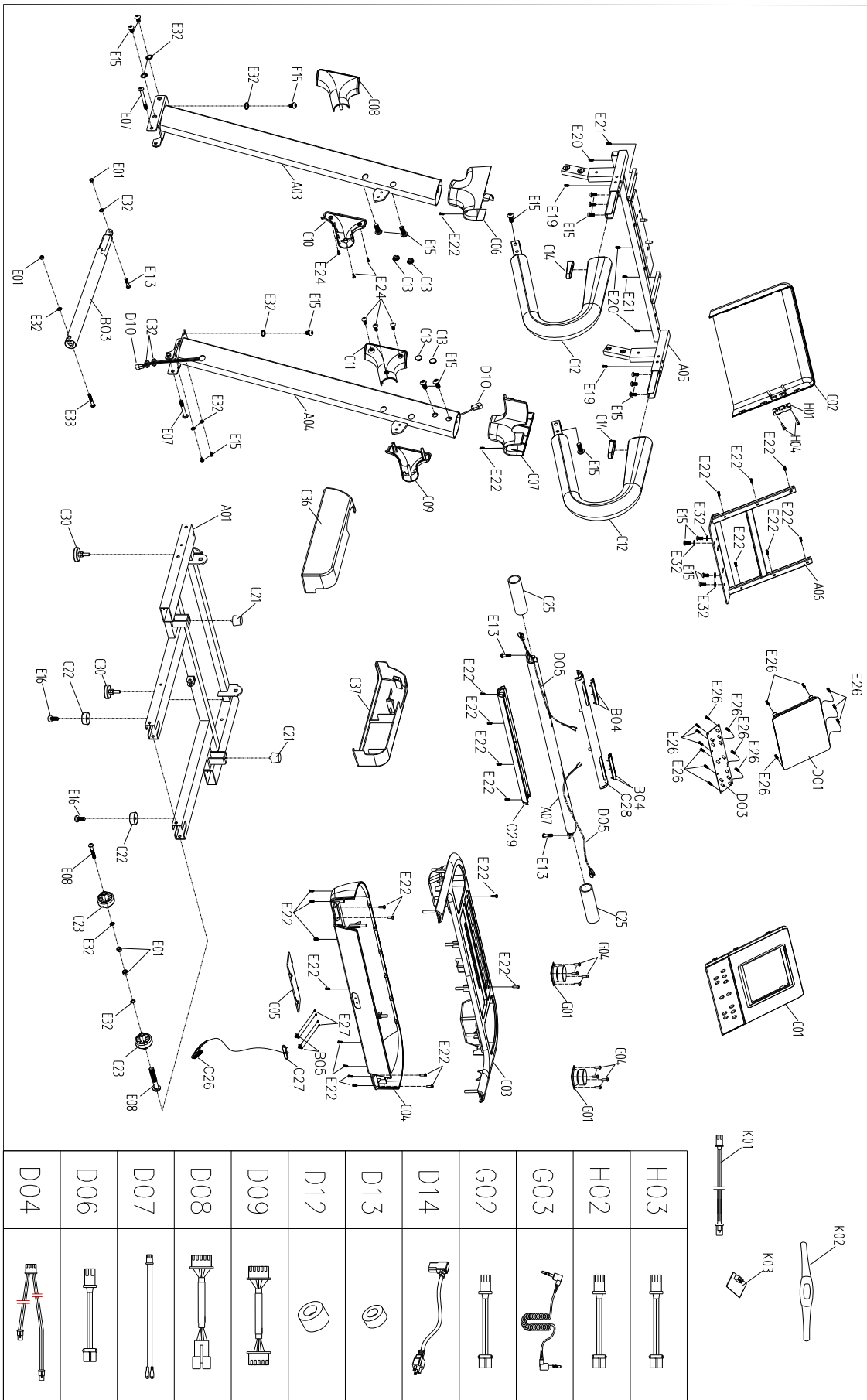

| # | DESCRIPTION | QTY |
|-----|---|-----|
| A01 | Base assembly | 1 |
| A02 | Main frame assembly | 1 |
| A03 | Left column assembly | 1 |
| A04 | Right column assembly | 1 |
| A05 | Electronic watch stand assembly | 1 |
| A06 | Panel fixing frame assembly | 1 |
| A07 | Cross armrest tube assembly | 1 |
| A08 | Lifting frame assembly | 1 |
| B01 | Front roller | 1 |
| B02 | Rear roller | 1 |
| B03 | Air pressure rod | 1 |
| B04 | Pulse stainless steel sheet | 4 |
| B05 | Safety lock spring | 2 |
| B06 | Sleeve | 2 |
| B07 | Isometric 5# Allen wrench | 1 |
| B08 | Cross wrench | 1 |
| B09 | Step sleeve | 2 |
| B10 | Spring 1 | 4 |
| B11 | Isometric 6# Allen wrench | 1 |
| C01 | Upper cover of color screen panel | 1 |
| C02 | Panel lower cover | 1 |
| C03 | Electronic watch upper cover | 1 |
| C04 | Electronic watch lower cover | 1 |
| C05 | Middle and lower covers of electronic watch | 1 |
| C06 | Electronic watch left side cover | 1 |
| C07 | Electronic watch right side cover | 1 |
| C08 | Left column outer cover | 1 |
| C09 | Right column outer cover | 1 |
| C10 | Left column inner cover | 1 |
| C11 | Right column inner cover | 1 |
| C12 | Foam armrest | 2 |

| # | DESCRIPTION | QTY |
|-----|---------------------------|-----|
| C13 | Screw hole plug | 4 |
| C14 | Armrest tube plug | 2 |
| C15 | Motor upper cover | 1 |
| C16 | Motor lower cover | 1 |
| C17 | Left-rear corner guard | 1 |
| C18 | Right-rear corner guard | 1 |
| C19 | Oval cushion | 4 |
| C20 | Cushion | 4 |
| C21 | Tapered cushion | 2 |
| C22 | Flat foot pad | 2 |
| C23 | New handling wheel | 2 |
| C24 | Adjusting roller | 2 |
| C25 | Sponge grip | 2 |
| C26 | Safety lock clip | 1 |
| C27 | Safety lock | 1 |
| C28 | Grip pulse upper cover | 1 |
| C29 | Grip pulse lower cover | 1 |
| C30 | Adjustable foot pad | 2 |
| C31 | Multi wedge belt | 1 |
| C32 | Ring wire plug | 2 |
| C33 | Plastic gasket | 2 |
| C34 | EVA pad | 2 |
| C35 | EVA pad | 1 |
| C36 | Left bottom shield | 1 |
| C37 | Right bottom shield | 1 |
| C38 | Sidebar | 2 |
| C39 | Running belt | 1 |
| D01 | Electronic watch | 1 |
| D02 | Control circuit board | 1 |
| D03 | Button board | 1 |
| D04 | EKG grip pulse upper line | 1 |

| # | DESCRIPTION | QTY |
|-----|--------------------------------------|-----|
| D05 | EKG grip pulse lower line | 2 |
| D06 | Safety switch upper line | 1 |
| D07 | Safety switch lower line | 1 |
| D08 | Electronic watch upper line | 1 |
| D09 | Electronic watch middle line 1 | 1 |
| D10 | Electronic watch lower line | 1 |
| D11 | Magnetic sensor | 1 |
| D12 | Magnetic ring | 1 |
| D13 | Core | 1 |
| D14 | Standard power cable | 1 |
| D15 | Square boat-shaped switch | 1 |
| D16 | Power socket | 1 |
| D17 | Overload protector | 1 |
| D18 | AC individual line | 1 |
| D19 | AC individual line | 2 |
| D20 | AC individual line | 1 |
| D21 | AC individual line | 1 |
| D22 | Grounding wire | 1 |
| D23 | DC motor | 1 |
| D24 | Running board | 1 |
| D25 | Lifting motor | 1 |
| E01 | Type-I lock nut | 20 |
| E02 | Type-I lock nut | 6 |
| E03 | Hexagon socket flat round head screw | 1 |
| E04 | Hexagon socket flat round head screw | 1 |
| E05 | Hexagon socket flat round head screw | 2 |
| E06 | Half round head square neck bolt | 2 |
| E07 | Hexagon socket flat round head screw | 2 |
| E08 | Hexagon socket flat round head screw | 2 |
| E09 | Hexagon socket head cap screw | 2 |
| E10 | Hexagon socket head cap screw | 1 |

| # | DESCRIPTION | QTY |
|-----|---|-----|
| E11 | Hexagon socket flat round head screw | 2 |
| E12 | Half round head square neck bolt | 6 |
| E13 | Hexagon socket flat round head screw | 3 |
| E14 | Hexagon socket countersunk head screw | 4 |
| E15 | Hexagon socket flat round head screw | 24 |
| E16 | Cross recessed pan head screw | 2 |
| E17 | Cross recessed pan head screw | 7 |
| E18 | Cross recessed pan head screw | 1 |
| E19 | Cross recessed pan head tapping screw | 2 |
| E20 | Cross recessed pan head tapping screw | 3 |
| E21 | Cross recessed pan head tapping screw | 2 |
| H01 | USB module | 1 |
| H02 | USB cable | 1 |
| H03 | Audio socket cable | 1 |
| H04 | Cross recessed pan head tapping screw | 2 |
| E22 | Cross recessed pan head tapping screw | 26 |
| E23 | Cross recessed pan head self-drilling | 17 |
| E24 | Cross recessed countersunk head tapping | 6 |
| E25 | Cross recessed pan head tapping screw | 4 |
| E26 | Cross recessed pan head tapping screw | 16 |
| E27 | Cross recessed pan head tapping screw | 4 |
| E28 | Large washer, grade C nail | 6 |
| E29 | Plain washer, grade C | 8 |
| E30 | Standard spring washer | 2 |
| E31 | Internal teeth locking washer | 2 |
| E32 | Internal teeth locking washer | 27 |
| E33 | Hexagon socket flat round head screw | 1 |
| E34 | Cross pan head self-drilling screw | 6 |
| G01 | Horn | 2 |
| G02 | Horn cable | 2 |
| G03 | MP3 cable | 1 |

| # | DESCRIPTION | QTY |
|-----|--|-----|
| G04 | Cross recessed pan head tapping screw | 8 |
| J01 | Filter | 1 |
| J02 | Reactor | 1 |
| J03 | AC individual line L350 blue | 1 |
| J04 | Grounding wire L350, yellow-green | 1 |
| J05 | Cross recessed pan head self-drilling tapping screw ST4.2*12 | 4 |
| K01 | Wireless heart rate lower line | 1 |
| K03 | POLAR wireless receiver | 1 |

A successful exercise program consists of a warm-up, aerobic exercise, and a cool-down. Do the entire program at least two and preferably three times a week, resting for a day between workouts. After several months, you can increase your workouts to four or five times per week.

WARMING UP

The purpose of warming up is to prepare your body for exercise and to minimize injuries. Warm up for two to five minutes before strength-training or aerobic exercising. Perform activities that raise your heart rate and warm the working muscles. Activities may include brisk walking, jogging, jumping jacks, jump rope, and running in place.

STRETCHEN

Stretching while your muscles are warm after a proper warm-up and again after your strength or aerobic training session is very important. Muscles stretch more easily at these times because of their elevated temperature, which greatly reduces the risk of injury. Stretches should be held for 15 to 30 seconds.

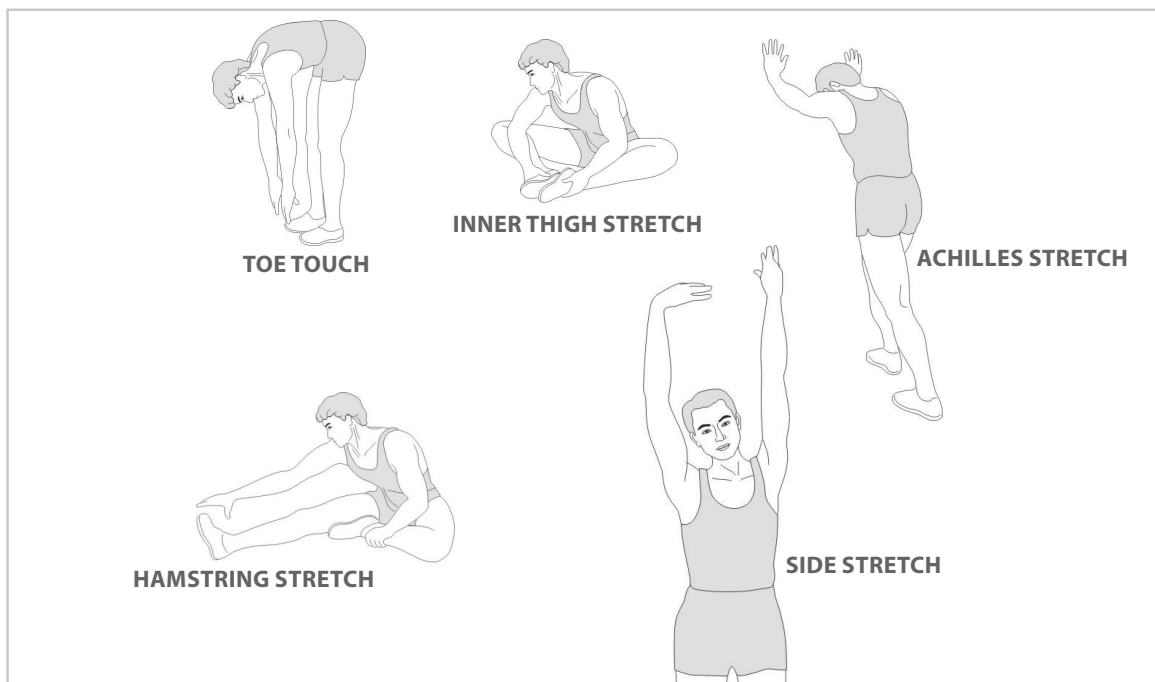

COOLING DOWN

The purpose of cooling down is to return the body to its normal or near normal, resting state at the end of each exercise session. A proper cool-down slowly lowers your heart rate and allows blood to return to the heart.

virtu profit

For questions or missing parts please contact your dealer.